

AM000055

Accessories • Displacement and angular measurement - Magnetic rings

accessories magnetic, Magnet ring, Ø102mm, Hole diameter 20, Pin length 3.2mm, 100pin, Aluminum

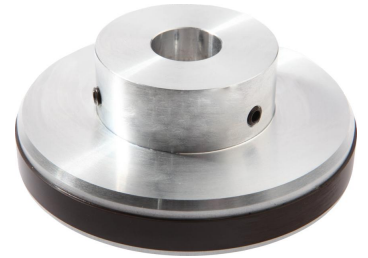

Electrical features

Pin length	3.2 mm
Number of pins	100

Mechanical features

Diameter	102 mm
Hole diameter	20 mm
Material	Aluminum

Classification

ETIM 8	EC002179 Measuring wheel
--------	--------------------------

More

IPF Product Group	900 accessories
packaging dimensions	160 x 240 x 42 mm
gross weight	414 g
Customs tariff number	85051990
WEEE number	40951076
Reach-compliant	Yes
RoHS-compliant	Yes

Dimensional drawing

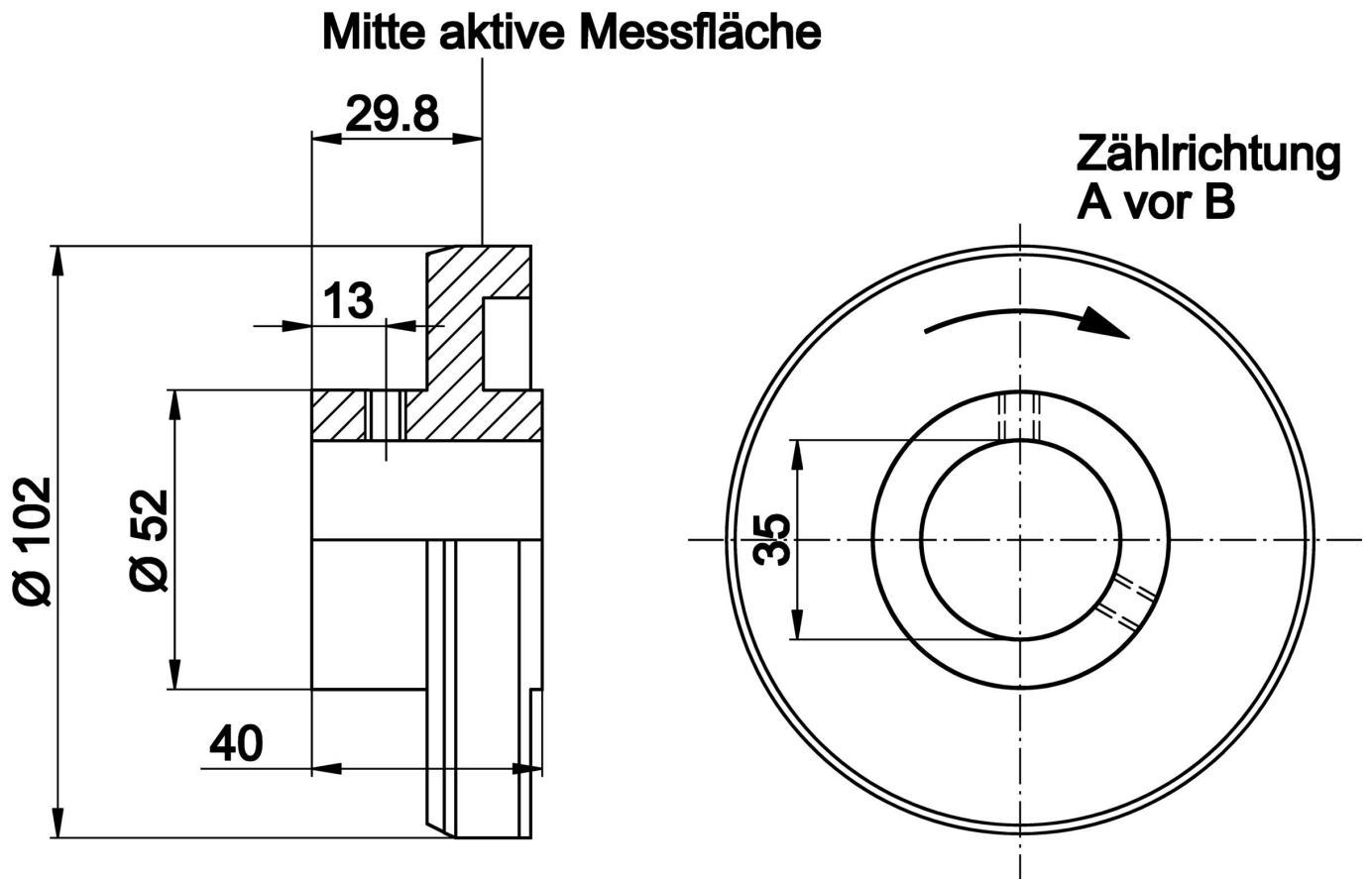

Installation

Mounting / installation may only be carried out by a qualified electrician!



Disposal

WEEE number according to § 6 para. 3
ElektroG: 40951076

Safety warnings

- / Before initial operation, please make sure to follow all safety instructions that may be provided in the product information.
- / Never use these devices in applications where the safety of a person depends on their functionality.