

AO000649

Accessories • Filter

Accessories Optical, bandpass filter, M30.5x0.5, filter color grey, transmission 1.6%, transmitted wavelength range 425-675nm, aluminum+glass



The use of optical filters is a cost-effective means of optimizing image information. In most cases, the basic idea is to increase the contrast in the resulting image. This can be achieved, for example, by suppressing interfering wavelength ranges in the light spectrum, so that colored features can be brightened or darkened, as when using colored illumination. Interfering extraneous light influences can be avoided or simply the wavelengths of the light used can be limited so that the camera sensor works at its optimum.

Mechanical features

Outer diameter	32.5 mm
Thread pitch	0.5 mm
Height	5 mm
Inner diameter	25.5 mm
Material	Aluminum
Active area material of sensor	glass
Thread dimension	M30.5

Optical features

Permeable wavelength range	625 - 675 nm
Transparency	1.6 %

Other features

Filter color	grey
--------------	------

Classification

ETIM 8	EC001637 Digital Camera Accessories/Spare Parts (Photo)
--------	---

More

IPF Product Group	914 accessories camera sensors
packaging dimensions	
gross weight	
Customs tariff number	90022000
WEEE number	40951076
Reach-compliant	Yes
RoHS-compliant	Yes

Dimensional drawing

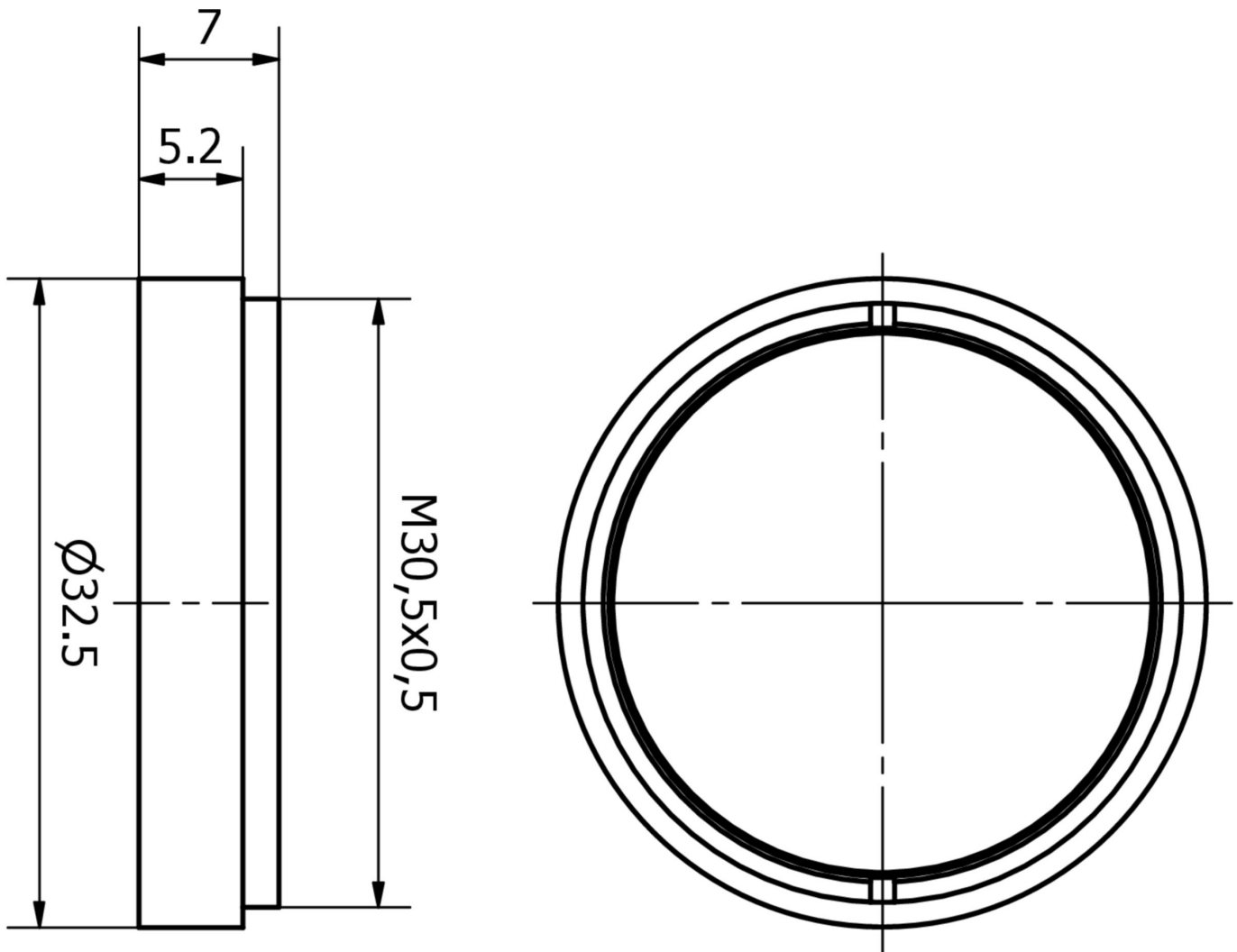

Installation

Mounting / installation may only be carried out by a qualified electrician!



Disposal

WEEE number according to § 6 para. 3
ElektroG: 40951076

Safety warnings

- / Before initial operation, please make sure to follow all safety instructions that may be provided in the product information.
- / Never use these devices in applications where the safety of a person depends on their functionality.