

AV000095

Connection technology • Cable sockets / connectors pre-assembled on one side

accessories, Connection cable, 5m, M23 Female (socket) 12pin Straight, Free conductor end, 10wire, Metal, Shielded



ipf cable sockets are used primarily for establishing the electrical connection of sensors. Their features are characterized by rugged design, the highest protection classes (IP67 | IP68 | IP69K) and, if desired, with 360° shielding. With the features: bus-ready, suitable for use with drag chains and robots, resistance to oil and chemicals, resistance to welding sparks, their resistance to cleaning agents or high-pressure and steam-jet cleaning, the expanded temperature range of up to +230°C, the rapid interconnection technology and special data transmission properties, the cable sockets meet all requirements in automation technology.

Electrical features

Type of plug-in contact, A connection	Female (socket)
Type of cable	Multi-core
Type of A electrical connection	M23
Type of B electrical connection	Free conductor end
Number of pins of A connection	12
Shielded	Yes

Mechanical features

Number of cores	10
Cable length	5 m
Cable infeed of A connection	straight
Housing material	Metal
Suitable for trailing chain	Yes
Line diameter	6 mm

Other features

Flame retardant	No
-----------------	----

Classification

ETIM 8	EC001855 Assembled sensor-actuator cable
--------	--

More

IPF Product Group	900 accessories
packaging dimensions	220 x 160 x 45 mm
gross weight	340 g
Customs tariff number	85444290
WEEE number	40951076
OzDS-compliant	Yes
POP-compliant	Yes
Reach-compliant	Yes
RoHS-compliant	Yes

Connection

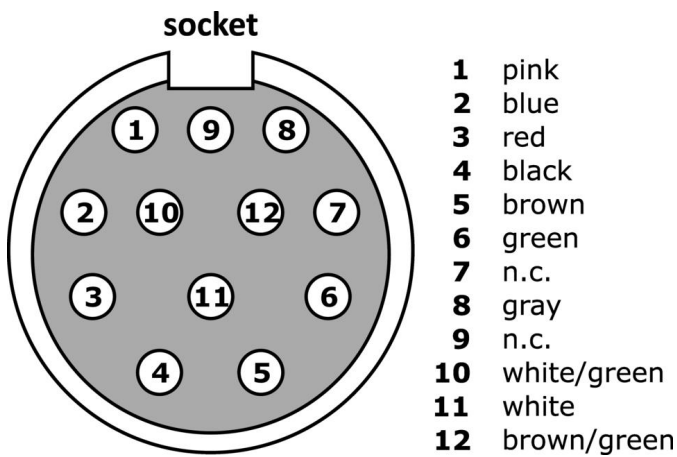

Dimensional drawing

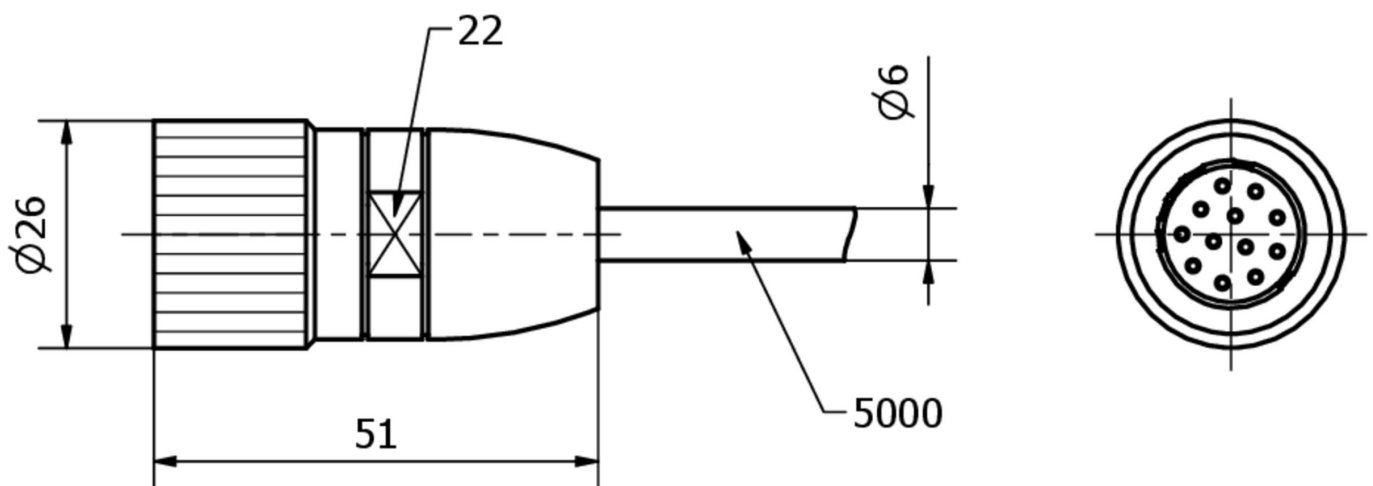

Extract accessories program**AY000141**

Plastic sheath, Ø17mm, Inner diameter 10mm, -40-250°C, Glass fiber with silicone rubber, Short-term resistance to weld spatter 1200°C, Tensile strength 400N, Flexible, Flame retardant, yard good

You can find further accessories on our homepage

**Installation**

Mounting / installation may only be carried out by a qualified electrician!

**Disposal**

WEEE number according to § 6 para. 3
ElektroG: 40951076

Safety warnings

- / Before initial operation, please make sure to follow all safety instructions that may be provided in the product information.
- / Never use these devices in applications where the safety of a person depends on their functionality.