

AY000004

Accessories • Mounting

accessories sensor, Ø10mm, Plastic, For sensor 10mm, for Wall mounting, Screw mounting



Mechanical features

Diameter	10 mm
For sensor	10mm
Mounting method	Screw mounting
Nominal diameter	10 mm
Material	Plastic
To fix to	Wall mounting

Classification

ETIM 8	EC000127 Fixing clamp for cables/tubes
--------	--

More

IPF Product Group	900 accessories
packaging dimensions	120 x 100 x 25 mm
gross weight	20 g
Customs tariff number	39269097
WEEE number	40951076
Reach-compliant	Yes
RoHS-compliant	Yes

Dimensional drawing

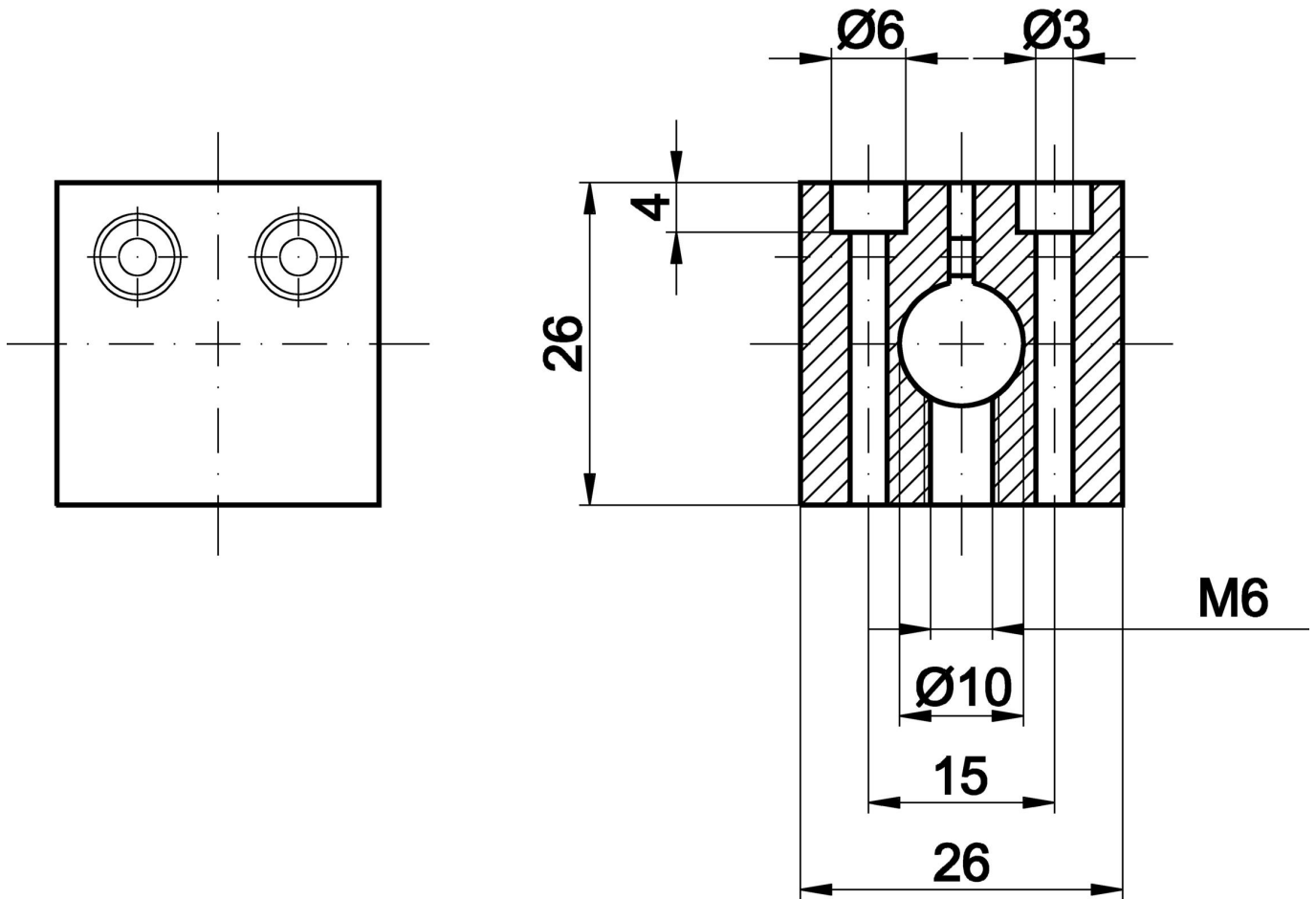

Installation

Mounting / installation may only be carried out by a qualified electrician!



Disposal

WEEE number according to § 6 para. 3
ElektroG: 40951076

Safety warnings

- / Before initial operation, please make sure to follow all safety instructions that may be provided in the product information.
- / Never use these devices in applications where the safety of a person depends on their functionality.