

## DT243103

### Pressure sensors • Pressure transmitter

Pressure transmitter, Ø24mm, 57 long, 0-40bar, 9-30V DC, G1/4 "A, 4-20mA, M12 plug connector 4-pin, IP67, stainless steel V4A



### compact design robust VA housing

The indestructible pressure transmitters of the DT24 series with ceramic measuring cell have been designed for use with all gaseous and liquid media of fluid group 2. The measured values can be easily output via the integrated analog output (4...20mA) on a PLC (programmable logic controller) or an external display device. The pressure transmitters impress with their very low long-term drift.

#### Advantages

- robust version in stainless steel housing (degree of protection IP67) and ceramic measuring cell
- media temperature range (-25 °C...+100 °C)
- short response time (< 3 ms)
- low long-term drift (≤0.1% per year)

#### Electrical features

Initial setting	0 - 40000 hPa
Response/decay time	3 ms
Type of analog output	4 - 20mA
Type of electrical connection	Connector M12
Load resistance (current output)	0.5 kOhm
No-load current	25 mA
Measuring range pressure	0 - 40 bar
Measurement method	Relative
Number of pins	4
Relative linearity deviation	0.5 %
Relative repeat accuracy	0.2 %
Protection class	III
Temperature drift over entire measuring range	1.5 %
Operating voltage (DC)	9 - 30 V
Electrical connection	M12 4-pin plug connector
Operating voltage	9-30VDC
ardTEEL_Schutzfunktionen	Short circuit protection   Reverse polarity protection

**Mechanical features**

Type of process connection	G1/4 inch
Design	Cylinder plain
Bursting pressure	140 bar
Diameter	23.9 mm
Storage temperature	-30 - 85 °C
Length	56.3 mm
Max. operating pressure	100 bar
Medium temperature	-25 - 100 °C
Wrench size	22 mm
Degree of protection (IP)	IP67
Housing material	Stainless steel 1.4404
Seal material at process connection	Plastic (FKM)
Long-term drift per year	0.1 %
Ambient temperature	-25 - 80 °C
dimensions	Ø23.9mm, 56.3mm long
Material of the process connection	Stainless steel 1.4404
Material of the measuring cell	Ceramic

**Other features**

Suitable for	Fluid group 2
--------------	---------------

**Classification**

ETIM 8
--------

**More**

IPF Product Group	361 pressure sensors (diverse)
packaging dimensions	105 x 43 x 43 mm
gross weight	85 g
Customs tariff number	90262020
WEEE number	40951076
Reach-compliant	Yes
RoHS-compliant	Yes
MTTF value	2236 year(s)

**Connection**

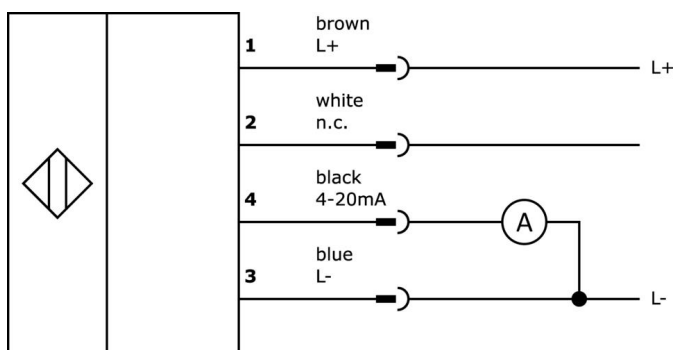

**Dimensional drawing**

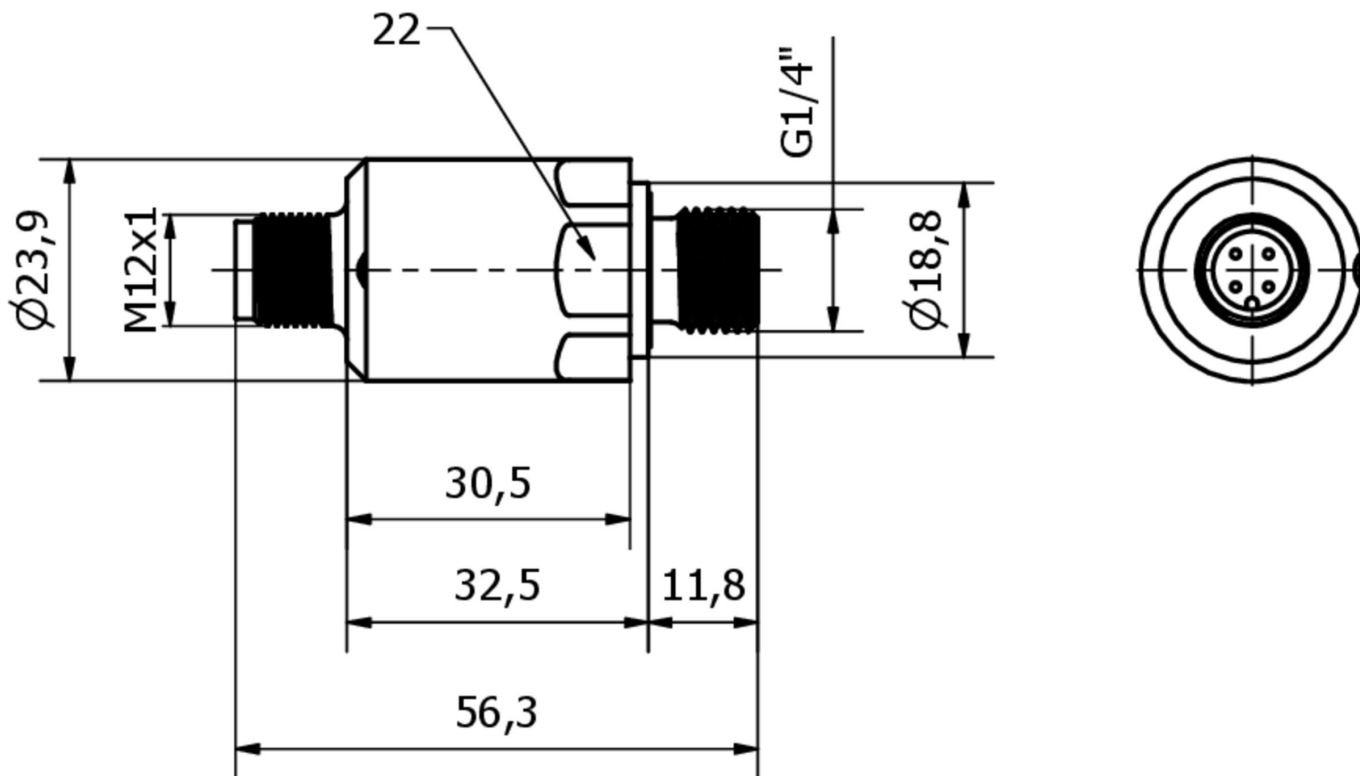

**Extract accessories program**

**VK205321**



Connection cable, 2m, M12 socket 4-pin angular, free cable end, 4x0.34mm<sup>2</sup>, PUR (polyurethane), Ø5.5mm, 250V, -25-90°C, IP67, shielded, suitable for trailing chain and torsion resistant, oils and cooling lubricants, welding area, silicone-free

**VK205325**



Connection cable, 2m, M12 socket 4-pin straight, free cable end, 4x0.34mm<sup>2</sup>, PUR (polyurethane), Ø5.5mm, 250V, -25-90°C, IP67, shielded, suitable for trailing chain and torsion resistant, oils and cooling lubricants, welding area, silicone-free

**VK003020**



Cable socket, angular, self-assembly, screw connection, Ø3-6.5mm, 4A, 240V, -25-90°C, M12 socket 4-pin, IP67, PBT

**VK003024**



Cable socket, Straight, Suitable for self-assembly, Screw connection, Ø3-6.5mm, 4A, 240V, -25-90°C, M12 Female (socket) 4pin, IP67, PBT

**AD000018**



Pressure accessories, adapter, G1/4 - G1/2, 24 long, stainless steel V4A, FKM

**AD000017**



Accessories pressure, adapter, G1/4, 26lang, V4A

**AD000026**



Accessories Throttle screw, M5x6mm, stainless steel 1.4404

You can find further accessories on our homepage

**Installation**

Mounting / installation may only be carried out by a qualified electrician!

**Disposal**

WEEE number according to § 6 para. 3  
ElektroG: 40951076

**Safety warnings**

- / Before initial operation, please make sure to follow all safety instructions that may be provided in the product information.
- / Never use these devices in applications where the safety of a person depends on their functionality.