

DW503107

Pressure sensors • Pressure monitor

Pressure sensor, Ø38mm 127lang, 0-600bar, 12-30V DC, G1/4 "A, 2x PNP NC/NO, 0-5/10V / 0/4-20mA, M12 plug connector 4-pin, IP67, PC (plastic), TFT display, IO-Link



TFT color display with plain text display IO-Link interface

The pressure sensors in the DW5x series for pressure ranges from -1bar...+600bar are the "Swiss army knives" among the pressure sensors from ipf electronic. Highly flexible for use with liquid and gaseous media in all conceivable applications, these devices leave nothing to be desired in terms of convenient operation and technical features. The sensors with IO-Link interface have a switching output and a second variable output that can be defined as a switching, analog or alarm output as required. All settings of the DW5x can be checked before practical use in an application using an "offline test function" without having to apply pressure to the sensors.

The focus is on the integrated, easy-to-read TFT color display with its extremely diverse options for different display modes. Just a few examples: Display of the pressure in plain text with trend display and accurate identification of the switching points or color display options for reaching previously defined switching points. But the potential of the easily switchable color display is far from exhausted.

The display is perfectly readable in any installation position, as the display can be rotated in 90° steps and the housing can also be continuously rotated by 305°. The sensors with full stainless steel measuring cell and integrated processor not only provide the pressure, but also determine a relative temperature value of the medium if required.

Electrical features

Response/decay time	10 ms
Number of switching outputs	2
Display	TFT display
Type of switching function	Programmable/configurable
Type of alarm output	PNP
Type of analog output	0 - 10V 0 - 20mA 0 - 5V 4 - 20mA
Type of electrical connection	Connector M12
Type of switching output	PNP/NPN
Turn-off delay	0 - 10 s
Rated switching current	250 mA
Readiness delay	2000 ms
Turn-on delay	0 - 10 s
Setting procedure	Parameterization
No-load current	40 mA
Measuring range pressure	0 - 600 bar
Measurement method	Relative
Number of pins	4
Relative linearity deviation	0.25 %
Relative repeat accuracy	0.15 %
Switching frequency	50 Hz
Voltage drop	2 V
Temperature drift over entire measuring range	1 %
Operating voltage (DC)	12 - 30 V
Suitable as limiter	Yes
Suitable as monitor	Yes
Number of analog output channels	1
ardSOCA_ElektrischerAnschluss	M12 4-pin plug connector
ardSOCA_Betriebsspannung	12-30VDC
ardTEEL_Lebensdauer	10 Millionen Lastwechsel
ardTEEL_Einstellungsbereich	0,2% vom Endwert zwischen Ein- und Ausschaltpunkt
ardTEEL_EinstellbareDaempfungszeitAnalogausgang	0 - 10 s
ardTEEL_EinstellbareDaempfungszeitAnzeigewert	0 - 10 s
ardTEEL_Schutzfunktionen	Reverse polarity protection Short circuit protection

Mechanical features

Type of process connection	G1/4 inch A
Design	Cylinder plain
Diameter	38 mm
Thread length	12 mm
Thread pitch	1.337 mm
Length	127 mm
Max. operating pressure	1200 bar
Medium temperature	-20 - 80 °C
Nominal pressure	600 bar
Wrench size	19 mm
Degree of protection (IP)	IP67
Housing material	Plastic PC
Seal material at process connection	Plastic (NBR)
Long-term drift per year	0.1 %
Ambient temperature	-20 - 70 °C
ardSOCA_Abmessungen	Ø38mm, 127mm long
ardTEME_WerkstoffDesProzessanschlusses	Edelstahl 1.4305
ardTEME_WerkstoffDerMesszelle	Stainless steel 1.4404
ardTEME_SchockUndVibrationsfestigkeit	Schock (EN 60068-2-27): 250m/s ² , Halbsinus Impulsform, 6 ms Impulsdauer, 1000 Impulse je Achse und Richtung Schwingen (EN 60068-2-6): 30 m/s ² , 10-150 Hz, 20 Zyklen in 90 min je Achse

Other features

Range of functions	Spitzenwertspeicher
Suitable for	Fluid group 2
Measuring display	Relative
IO-Link version	V1.1.4
Relative measurement accuracy	0.5 %
ardTE00_Anwendungen	Hydraulic applications Pneumatic applications Zweipunktreglung

Classification

ETIM 8	
--------	--

More

IPF Product Group	360 pressure sensors
packaging dimensions	160 x 99 x 60 mm
gross weight	284 g
Customs tariff number	90262020
WEEE number	40951076
Reach-compliant	Yes
RoHS-compliant	Yes
MTTF value	1023 year(s)

Connection

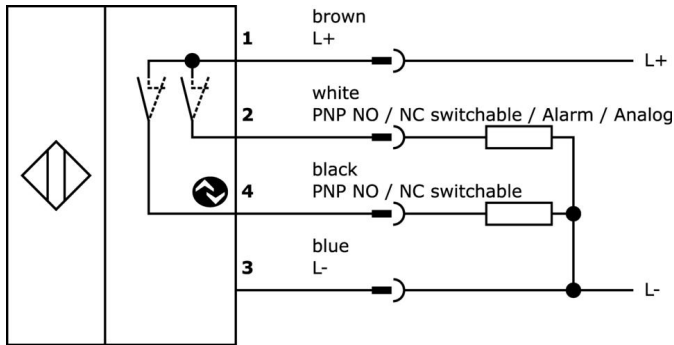

Dimensional drawing

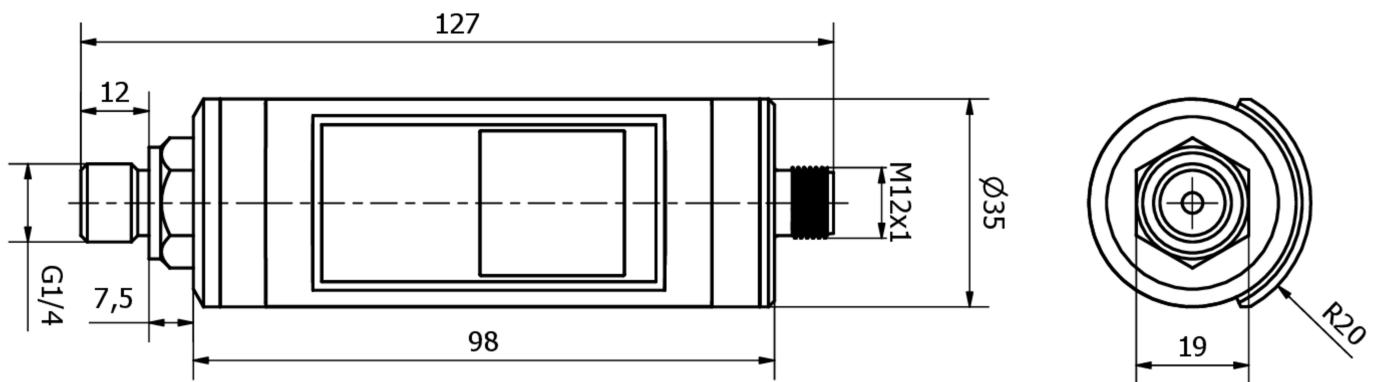

Extract accessories program

VK205321

Connection cable, 2m, M12
 Female (socket) 4pin Angular, Free conductor end, 4x0.34mm², PUR (Polyurethane), Ø5.5mm, 250V, -25-90°C, IP67, Shielded, Suitable for trailing chain and torsion resistant, Oil and cooling lubricants, Welding area, Silicon...

VK205325

Connection cable, 2m, M12
 Female (socket) 4pin Straight, Free conductor end, 4x0.34mm², PUR (Polyurethane), Ø5.5mm, 250V, -25-90°C, IP67, Shielded, Suitable for trailing chain and torsion resistant, Oil and cooling lubricants, Welding area, Silico...

AD000018

Pressure accessories, adapter, G1/4 - G1/2, 24 long, stainless steel V4A, FKM

AD000028

Pressure accessories, adapter, G1/4 - G1/2, 24 long, galvanized steel (galv.steel), NBR

AD000020

Accessories pressure, profile seal G1/4", Ø16,5mm 1,5high, fluorocarbon rubber FKM, green

VY000005

IO-Link master, 41x24x67mm, IO-Link, M12, With USB interface

You can find further accessories on our homepage



Installation

Mounting / installation may only be carried out by a qualified electrician!



Disposal

WEEE number according to § 6 para. 3 ElektroG: 40951076

Safety warnings

- /** Before initial operation, please make sure to follow all safety instructions that may be provided in the product information.
- /** Never use these devices in applications where the safety of a person depends on their functionality.
- /** Any software, drivers or IODD files that may be required to operate your device can be downloaded free of charge from our homepage: www.ipf-electronic.com