

## EF750170

### camera additional lighting • Dark field lights

LED dark field light, 130x141x12mm, inner diameter 75mm, white light, 6W, 5000K, 22-26V DC, M8 connector 4-pin, IP54, aluminum+PMMA

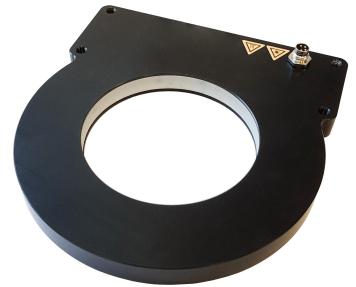

**Suitable for continuous and flash operation  
For highlighting surface defects, scratches or engravings**

The illumination of the test objects is achieved by the lateral light exit at very flat brackets. This illumination, also described as dark field illumination, is ideal for inspecting object surfaces or edges, as the lateral illumination means that the light is only reflected back to the camera from angled surfaces, such as scratches or relief structures.

The housing of the horizontal ring lights is particularly compact and can therefore also be used optimally in space-critical inspections. Due to the compact housing and shadow-free illumination, horizontal ring lights are also often used for barcode reading applications.

#### Electrical features

Type of electrical connection	Connector M8
Rated operating current	300 mA
Flash controller	internal
Power	6 W
Max. peak current	1200 mA
Number of pins	4
Protection class	III
Operating voltage (DC)	22,8 - 25,2 V
ardSOCA_ElektrischerAnschluss	M8 4-pin plug connector
ardSOCA_Betriebsspannung	23-25VDC

#### Mechanical features

Width	130 mm
Height	12 mm
Inner diameter	100 mm
Length	141 mm
Degree of protection (IP)	IP54
Front screen scattering behavior	diffuse
Housing material	Aluminum
Front screen material	Polymethyl methacrylate
Working distance range	1 - 30 mm
Ambient temperature	10 - 30 °C
ardSOCA_Abmessungen	141x130x12mm

**Optical features**

Color temperature	5000 K
Lamp	LED
Light source	White light
Risk group	0

**Other features**

Relative air humidity (non-condensing)	30 - 70 %
Operational mode	Permanent operation   Flash operation

**Classification**

ETIM 8	EC000348 Machine and workbench light
--------	--------------------------------------

**More**

IPF Product Group	915 camera illumination
packaging dimensions	230 x 170 x 45 mm
gross weight	491 g
Customs tariff number	94054239
WEEE number	40951076
Reach-compliant	Yes
RoHS-compliant	Yes

**Connection**

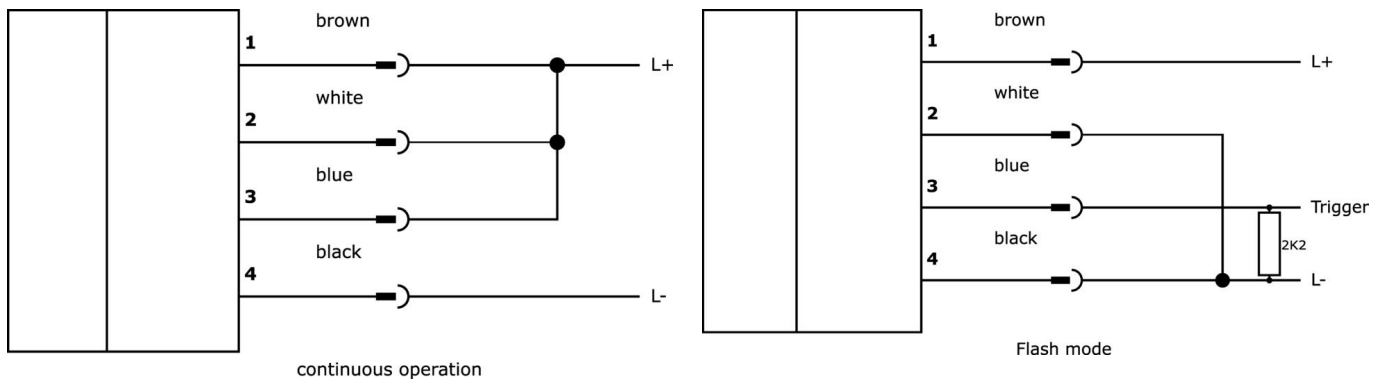

Dimensional drawing

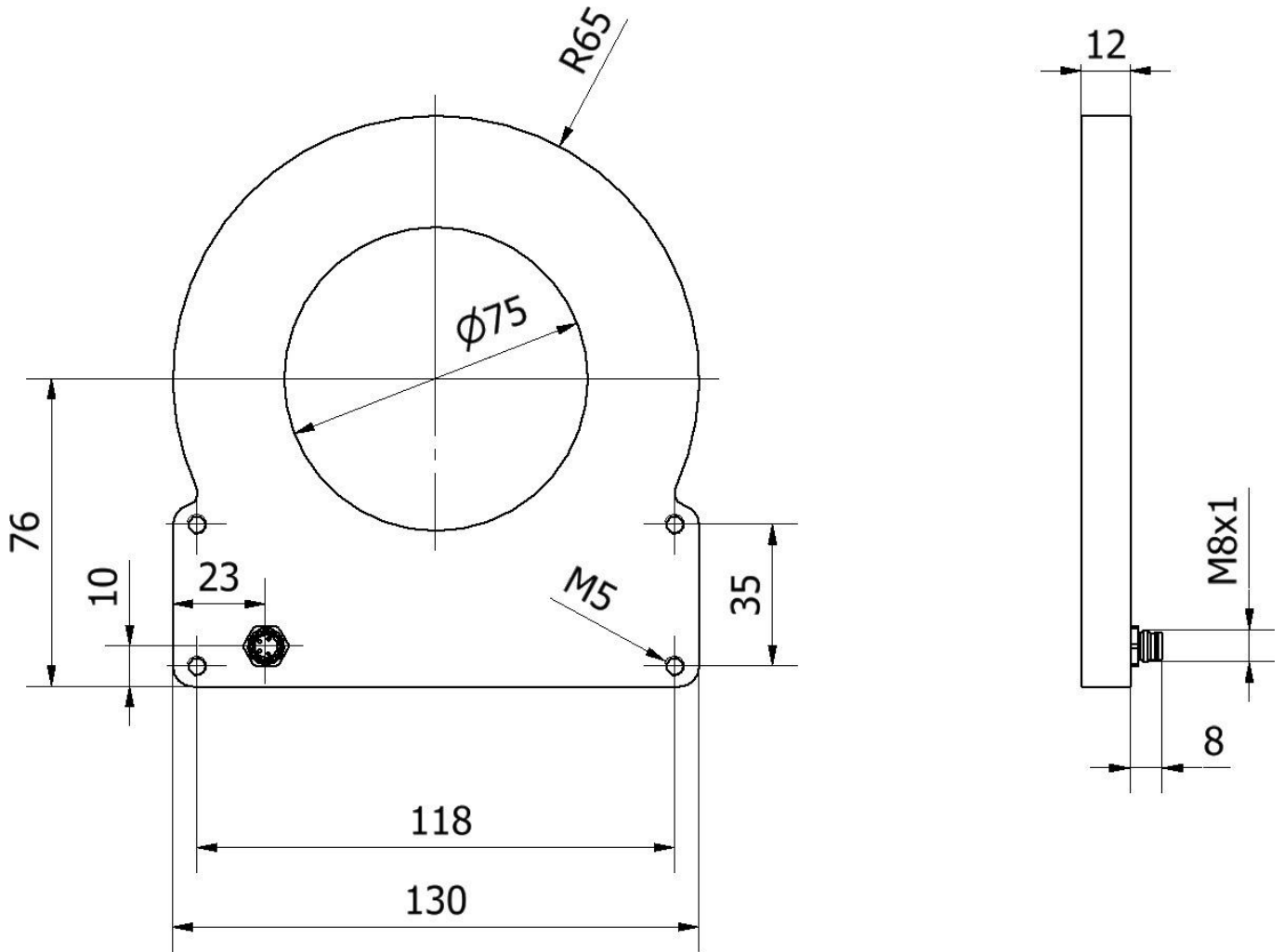

**Extract accessories program**

**VK200371**



Connection cable, 2m, M8 Female (socket) 4pin Angular, Free conductor end, 4x0.34mm<sup>2</sup>, PUR (Polyurethane), Ø4.7mm, 30V, -30-90°C, IP67, Suitable for trailing chain and torsion resistant, Oil and cooling lubricants, Welding area, Silicone-free

**VK200375**



Connection cable, 2m, M8 Female (socket) 4pin Straight, Free conductor end, 4x0.34mm<sup>2</sup>, PUR (Polyurethane), Ø4.7mm, 30V, -30-90°C, IP67, Suitable for trailing chain and torsion resistant, Oil and cooling lubricants, Welding area, Silicone-free

**VK030F81**



Connection cable, 0.3m, M8 socket 4-pin angular, M12 connector 4-pin straight, 4x0.34mm<sup>2</sup>, PUR (polyurethane), 60V, IP67, suitable for trailing chain and torsion resistant, oils and cooling lubricants, welding area, silicone-free

**VK030F85**



Connection cable, 0.3m, M8 socket 4-pin straight, M12 connector 4-pin straight, 4x0.34mm<sup>2</sup>, PUR (polyurethane), 60V, IP67, suitable for trailing chain and torsion resistant, oils and cooling lubricants, welding area, silicone-free

**VK003071**



Cable socket, Angular, Suitable for self-assembly, Soldering connection, Ø3.5-5mm, 4A, 30V, -40-85°C, M8 Female (socket) 4pin, IP67, Brass

**VK003075**



Cable socket, Straight, Suitable for self-assembly, Soldering connection, Ø3.5-5mm, 4A, 30V, -40-85°C, M8 Female (socket) 4pin, IP67, Brass

**VK030F71**



Connection cable, 0.3m, M8 socket 4-pin angular, M8 connector 4-pin straight, 4-core, PUR (polyurethane), suitable for trailing chain and torsion resistant, oils and cooling lubricants, welding area, silicone-free

**VK030F75**



Connection cable, 0.3m, M8 socket 4-pin straight, M8 connector 4-pin straight, 4-core, PUR (polyurethane), suitable for trailing chain and torsion-resistant, oils and cooling lubricants, welding area, silicone-free

**VK06F001**



Line for camera lighting in continuous operation on OC53 with internal flash controller, 0.6m, M8 socket 4-pin straight, M8 connector 4-pin straight, 4-wire

You can find further accessories on our homepage



**Installation**

Mounting / installation may only be carried out by a qualified electrician!



**Disposal**

WEEE number according to § 6 para. 3 ElektroG: 40951076

**Safety warnings**

/ Before initial operation, please make sure to follow all safety instructions that may be provided in the product information.

/ Never use these devices in applications where the safety of a person depends on their functionality.

/ LED lighting systems can generate intensive UV radiation, which can damage your eyes in case of improper use. The manufacturer cannot be held responsible for damages that result from improper use or connection.