

EM550121

LED lights • Machine and bench lights

LED machine light, 55x300x20mm, white light, 13W, 2000lx, 5000K, 22-28V DC, M12-connector 4-pin, IP67, aluminum + float glass tempered

- / Front screen made of tempered float glass
- / Light color neutral white
- / Increased resistance to cooling lubricants
- / Increased resistance to chip bombardment



Large angle of emitted beam Anodized aluminum housing

These resilient lights offer the optimum combination of brightness, output, design and degree of protection. With 150 lumens per watt and an angle of emitted beam of 120 degrees, they are the right choice when a lot of light is needed. They are resistant to the most common coolants and lubricants and can therefore be used in harsh environments.

Electrical features

Type of electrical connection	Connector M12
Rated operating current	542 mA
Power	13 W
Luminous flux	1950 lm
Number of pins	4
Protection class	III
Reverse polarity protection	Yes
Operating voltage (DC)	22 - 28 V
ardSOCA_ElektrischerAnschluss	M12 4-pin plug connector
ardTEEL_Lichtausbeute	150 lm/W
ardSOCA_Betriebsspannung	22-28VDC

Mechanical features

Design	Cuboid
Width	55 mm
Height	20 mm
Storage temperature	-20 - 40 °C
Length	300 mm
Degree of protection (IP)	IP67
Front screen scattering behavior	diffuse
Housing material	Aluminum
Front screen material	Float glass tempered
Ambient temperature	-20 - 40 °C
ardSOCA_Abmessungen	300x55x20mm

Optical features

Illuminance at 500mm distance	2000 lx
Illumination in the center (distance 1 m)	500 lx
Color temperature	5000 K
Lamp	LED
Light source	White light
Angle of beam spread	120 °
Risk group	0

Other features

Harsh environmental conditions	Yes
--------------------------------	-----

Classification

ETIM 8	EC000348 Machine and workbench light
--------	--------------------------------------

More

IPF Product Group	190 machine illuminations
packaging dimensions	625 x 85 x 65 mm
gross weight	770 g
Customs tariff number	94054239
WEEE number	40951076
Reach-compliant	Yes
RoHS-compliant	Yes

Connection

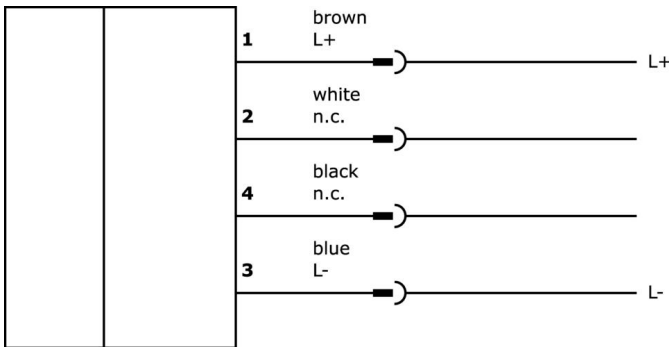

Dimensional drawing

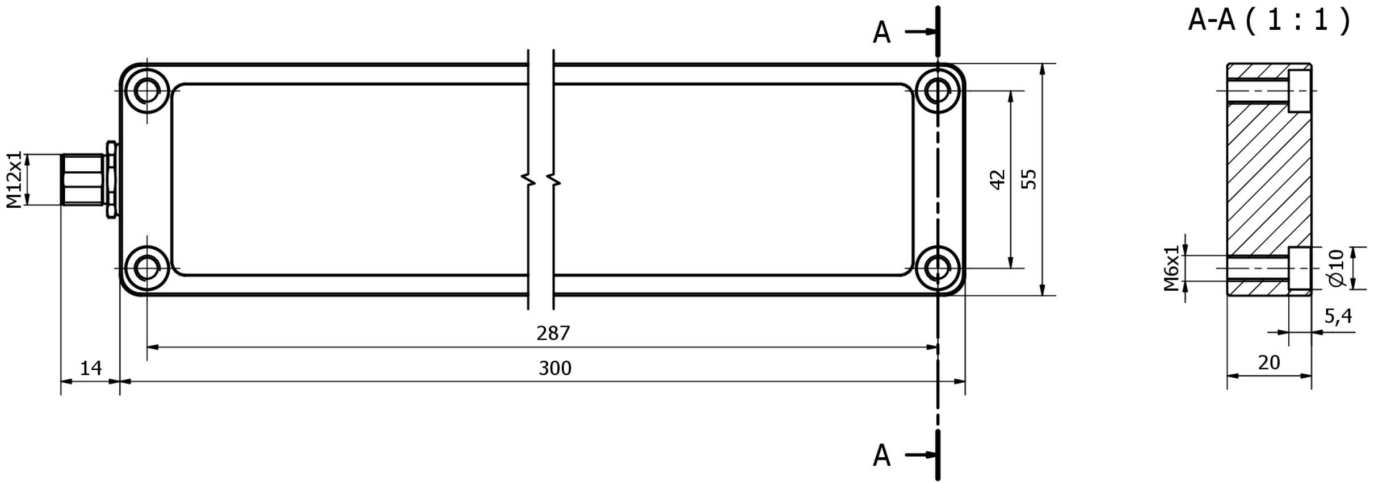

Extract accessories program

NG400501



DC power supply, 1-phase, 125x114x40mm, 24-28V, 5A, 90-264V AC 50Hz, 90-264V AC 60Hz, 127-370V DC, screw connection, IP20, aluminum, stabilized, pulsed output voltage

VY000007



LED brightness module, 55x120x80mm, 4A, 24V DC, M12-connector, IP40, plastic

VK200021



Connection cable, 2m, M12 Female (socket) 3pin Angular, Free conductor end, 3x0.34mm², PUR (Polyurethane), Ø4.3mm, 250V, -30-90°C, IP67, Suitable for trailing chain and torsion resistant, Oil and cooling lubricants, Welding area, Silicone-free

VK200025



Connection cable, 2m, M12 Female (socket) 3pin Straight, Free conductor end, 3x0.34mm², PUR (Polyurethane), Ø4.3mm, 250V, -30-90°C, IP67, Suitable for trailing chain and torsion resistant, Oil and cooling lubricants, Welding area, Silicone-free

VK200321



Connection cable, 2m, M12 Female (socket) 4pin Angular, Free conductor end, 4x0.34mm², PUR (Polyurethane), Ø4.7mm, 250V, -40-90°C, IP67, Suitable for trailing chain and torsion resistant, Oil and cooling lubricants, Welding area, Silicone-free

VK200325



Connection cable, 2m, M12 Female (socket) 4pin Straight, Free conductor end, 4x0.34mm², PUR (Polyurethane), Ø4.7mm, 250V, -40-90°C, IP67, Suitable for trailing chain and torsion resistant, Oil and cooling lubricants, Welding area, Silicone-free

VK003020



Cable socket, angular, self-assembly, screw connection, Ø3-6.5mm, 4A, 240V, -25-90°C, M12 socket 4-pin, IP67, PBT

VK003024



Cable socket, Straight, Suitable for self-assembly, Screw connection, Ø3-6.5mm, 4A, 240V, -25-90°C, M12 Female (socket) 4pin, IP67, PBT

VK003021



Cable socket, Angular, Suitable for self-assembly, Screw connection, Ø3-6.5mm, 4A, 60V, -25-90°C, M12 Female (socket) 5pin, IP67, PBT

You can find further accessories on our homepage



Installation

Mounting / installation may only be carried out by a qualified electrician!



Disposal

WEEE number according to § 6 para. 3 ElektroG: 40951076

Safety warnings

- /** Before initial operation, please make sure to follow all safety instructions that may be provided in the product information.
- /** Never use these devices in applications where the safety of a person depends on their functionality.
- /** LED lighting systems can generate intensive UV radiation, which can damage your eyes in case of improper use. The manufacturer cannot be held responsible for damages that result from improper use or connection.