

## ER1E8I42

### camera additional lighting • Ring lights

LED ring light, Ø156mm, infrared light, 7.2W, 850nm, 36° angle of emitted beam, M16 cable connector 12-pin 0.15m, IP64, aluminum+acrylic glass



### Internal flash controller

Selecting the right illumination is essential for all types of inspection tasks with a camera sensor, as only high-contrast images can be reproducibly evaluated. And illumination has a decisive influence here. The selection depends on various factors such as the distance to the test object, its size, the component criterion to be tested or the expected environmental conditions. Ring lights provide a direct, focused incident light that is particularly suitable for round test objects as it does not produce any hard object shadows.

Lights are available with different diameters of the lens aperture, different light colors and outputs. The internal flash controller enables flash operation of the lights up, which may be required for short exposure times of the camera systems.

#### Electrical features

Type of electrical connection	Cable connector M16
Rated operating current	800 mA
Flash controller	internal
Power	7.2 W
Max. peak current	1600 mA
Number of pins	12
Protection class	III
Operating voltage (DC)	19 - 30 V
Adjustable brightness	Yes
Flash duration	50 - 750 µs
ardSOCA_ElektrischerAnschluss	Cable connector M16 12-pin 0.15m
ardSOCA_Betriebsspannung	19-30VDC

#### Mechanical features

Outer diameter	156 mm
Height	39 mm
Inner diameter	66 mm
Cable length	0.15 m
Degree of protection (IP)	IP64
Front screen scattering behavior	clear
Housing material	Aluminum
Front screen material	Acrylic glass
Ambient temperature	5 - 45 °C
ardSOCA_Abmessungen	39mm high

**Optical features**

Number of LEDs	16
Lamp	LED
Light source	Infrared light
Wavelength of the sensor	850 nm
Angle of beam spread	36 °
Risk group	0

**Other features**

Operational mode	Flash operation
Changeable fronts	Yes

**Classification**

ETIM 8	EC000348 Machine and workbench light
--------	--------------------------------------

**More**

IPF Product Group	915 camera illumination
packaging dimensions	310 x 205 x 120 mm
gross weight	1156 g
Customs tariff number	94054239
WEEE number	40951076
Reach-compliant	Yes
RoHS-compliant	Yes

**Connection**

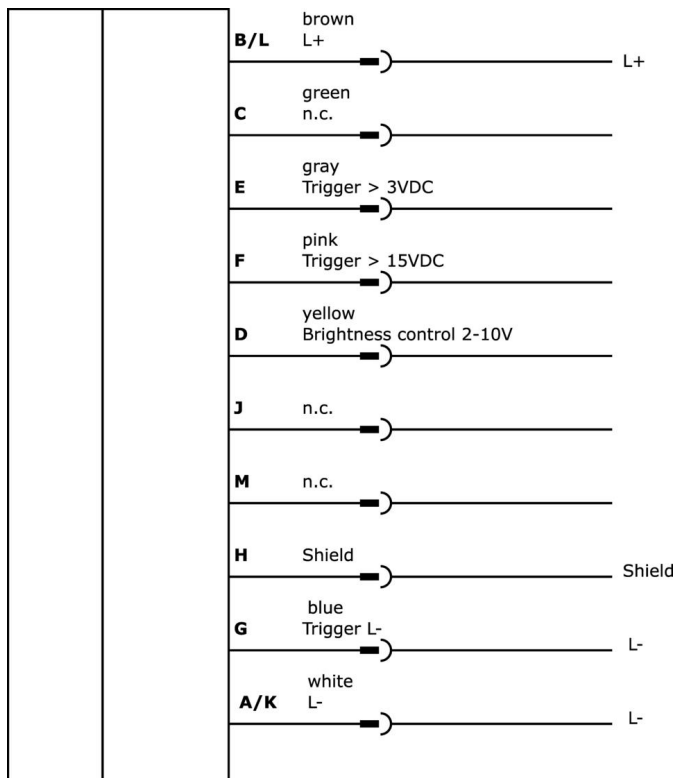

**Dimensional drawing**

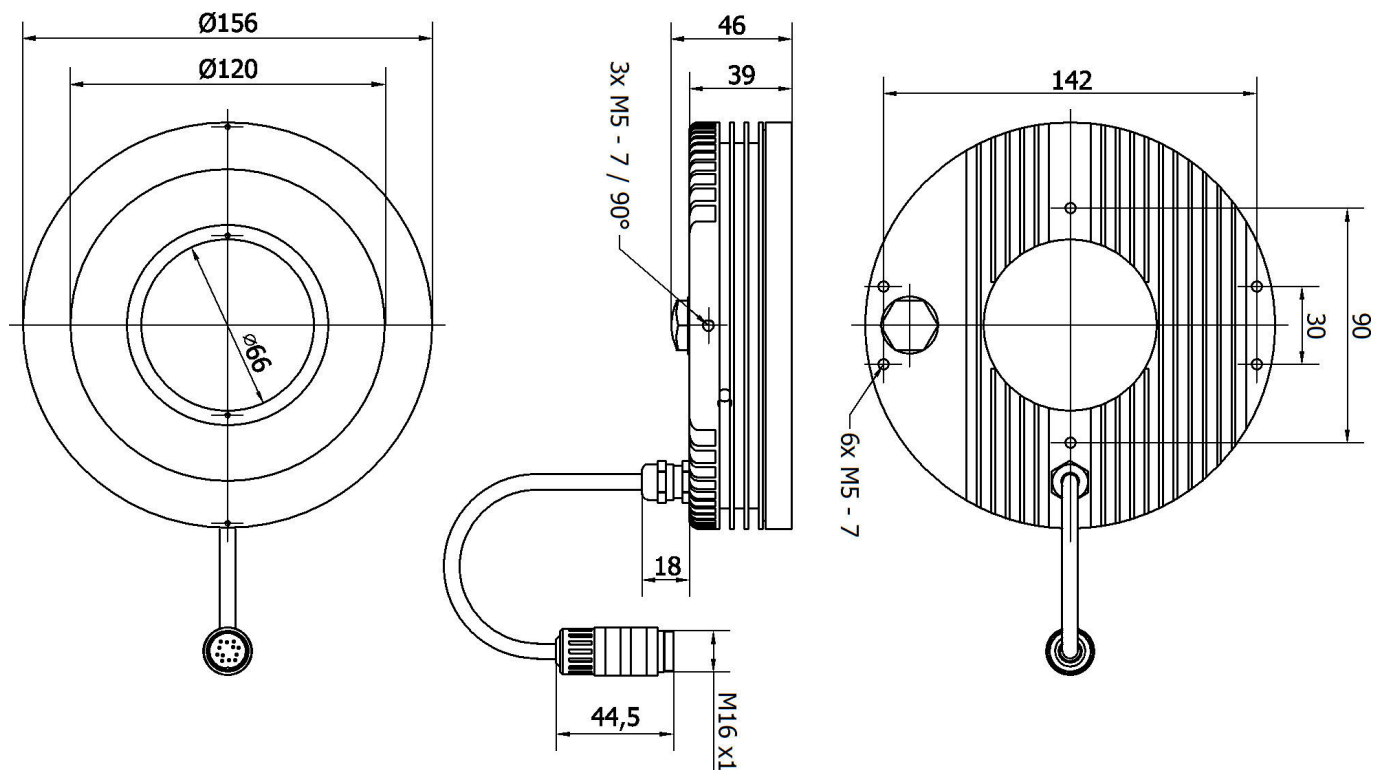

**Extract accessories program**

**VK255C44**



Connection cable, 2.5m, M16  
Female (socket) 12pin Straight,  
Free conductor end, 12wire,  
Other, 300V, IP67, Shielded,  
Suitable for trailing chain and  
torsion resistant, Oil and cooling  
lubricants

**VK505C44**



Connection cable, 5m, M16  
Female (socket) 12pin Straight,  
Free conductor end, 12wire,  
Other, 300V, IP67, Shielded,  
Suitable for trailing chain and  
torsion resistant, Oil and cooling  
lubricants

**AE000004**



accessories light, Mounting  
bracket, 47x105x78mm, Steel  
With powder coating

**VK000054**



Y-connection cable, 0.05m, 2x  
M12 12-pin straight, 1x M16  
socket 12-pin straight, 0.34mm<sup>2</sup>,  
PUR (polyurethane) black, Ø6.  
5mm, suitable for trailing chain  
and torsion resistant

**AE000005**



accessories light, Cover disc,  
Ø145mm 2long, Opal,  
Transparency 90%, Acrylic glass

**AE000010**



accessories light, Cover disc,  
Ø145mm 2long, Opal,  
Transparency 90%, Acrylic glass

You can find further accessories on our homepage



**Installation**

Mounting / installation may only be carried out by a qualified electrician!



**Disposal**

WEEE number according to § 6 para. 3  
ElektroG: 40951076

---

**Safety warnings**

- /** Before initial operation, please make sure to follow all safety instructions that may be provided in the product information.
- /** Never use these devices in applications where the safety of a person depends on their functionality.
- /** LED lighting systems can generate intensive UV radiation, which can damage your eyes in case of improper use. The manufacturer cannot be held responsible for damages that result from improper use or connection.