

## ERK50270

### camera additional lighting • Ring lights

LED ring light, Ø153mm, white light, 15W, 5000K, M8 connector 4-pin, IP50, aluminum+PMMA



### for permanent and switching operation

Selecting the right illumination is essential for all types of inspection tasks with a camera sensor, as only high-contrast images can be reproducibly evaluated. And illumination has a decisive influence here. The selection depends on various factors such as the distance to the test object, its size, the component criterion to be tested or the expected environmental conditions. Ring lights provide a direct, focused incident light that is particularly suitable for round test objects as it does not produce any hard object shadows.

Lights are available with different diameters of the lens aperture, different light colors and outputs. The internal flash controller enables flash operation of the lights up, which may be required for short exposure times of the camera systems.

#### Electrical features

Type of electrical connection	Connector M8
Rated operating current	625 mA
Power	15 W
Number of pins	4
Protection class	III
Operating voltage (DC)	24 V

#### Mechanical features

Diameter	153 mm
Height	31 mm
Inner diameter	96 mm
Degree of protection (IP)	IP50
Front screen scattering behavior	diffuse
Housing material	Aluminum
Front screen material	Polymethyl methacrylate
Ambient temperature	10 - 50 °C

#### Optical features

Number of LEDs	20
Color temperature	5000 K
Lamp	LED
Light source	White light
Angle of beam spread	45 °
Risk group	0

**Other features**

Operational mode	Permanent operation   Switching operation
Mounting on lenses	Yes
Changeable fronts	Yes

**Classification**

ETIM 8	EC000348 Machine and workbench light
--------	--------------------------------------

**More**

IPF Product Group	915 camera illumination
packaging dimensions	290 x 230 x 61 mm
gross weight	558 g
Customs tariff number	94054239
WEEE number	40951076
Reach-compliant	Yes
RoHS-compliant	Yes

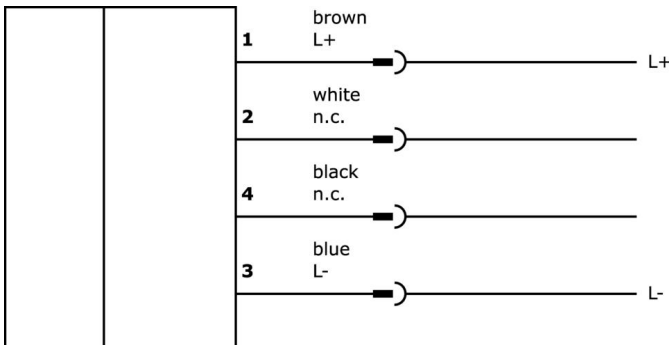
**Connection**

**Dimensional drawing**

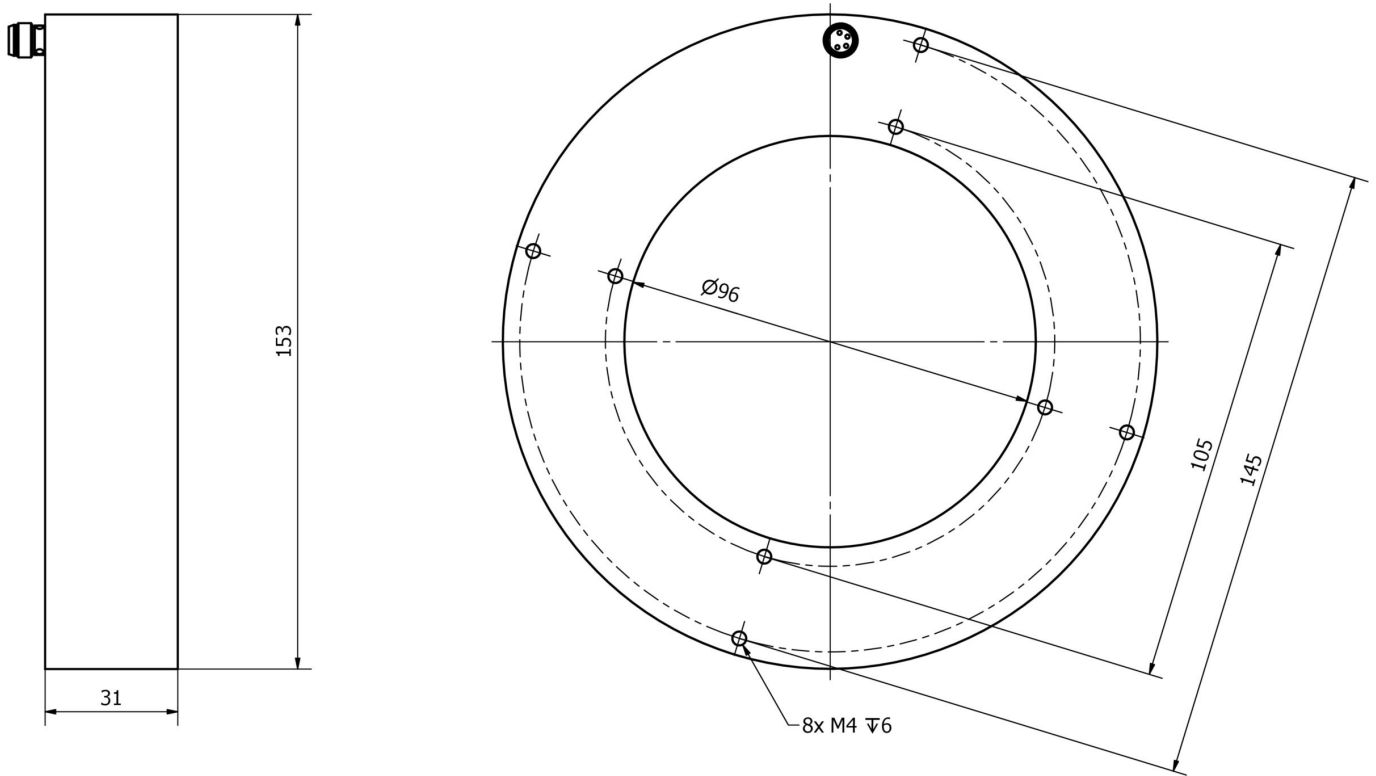

**Extract accessories program**

**VK200371**



Connection cable, 2m, M8 Female (socket) 4pin Angular, Free conductor end, 4x0.34mm<sup>2</sup>, PUR (Polyurethane), Ø4.7mm, 30V, -30-90°C, IP67, Suitable for trailing chain and torsion resistant, Oil and cooling lubricants, Welding area, Silicone-free

**VK200375**



Connection cable, 2m, M8 Female (socket) 4pin Straight, Free conductor end, 4x0.34mm<sup>2</sup>, PUR (Polyurethane), Ø4.7mm, 30V, -30-90°C, IP67, Suitable for trailing chain and torsion resistant, Oil and cooling lubricants, Welding area, Silicone-free

**VK000040**



Adaption, M8 Female (socket) 4pin Straight, M12 Male (connector) 4pin Straight, 24V, -25-85°C, IP67, Oil and cooling lubricants, Welding area

**VK000039**



Adaption, M8 Female (socket) 4pin Straight, M8 Male (connector) 3pin Straight, 24V, -25-85°C, IP67, Oil and cooling lubricants, Welding area

**VK030F71**



Connection cable, 0.3m, M8 socket 4-pin angular, M8 connector 4-pin straight, 4-core, PUR (polyurethane), suitable for trailing chain and torsion resistant, oils and cooling lubricants, welding area, silicone-free

**VK030F75**



Connection cable, 0.3m, M8 socket 4-pin straight, M8 connector 4-pin straight, 4-core, PUR (polyurethane), suitable for trailing chain and torsion-resistant, oils and cooling lubricants, welding area, silicone-free

**VK003071**



Cable socket, Angular, Suitable for self-assembly, Soldering connection, Ø3.5-5mm, 4A, 30V, -40-85°C, M8 Female (socket) 4pin, IP67, Brass

**VK003075**



Cable socket, Straight, Suitable for self-assembly, Soldering connection, Ø3.5-5mm, 4A, 30V, -40-85°C, M8 Female (socket) 4pin, IP67, Brass

You can find further accessories on our homepage

**Installation**

Mounting / installation may only be carried out by a qualified electrician!

**Disposal**

WEEE number according to § 6 para. 3  
ElektroG: 40951076

**Safety warnings**

- / Before initial operation, please make sure to follow all safety instructions that may be provided in the product information.
- / Never use these devices in applications where the safety of a person depends on their functionality.
- / LED lighting systems can generate intensive UV radiation, which can damage your eyes in case of improper use. The manufacturer cannot be held responsible for damages that result from improper use or connection.