

IB12C776

Inductive sensors • welding-proof

sensor inductive, M12x1 50long, Flush, Sn: 3, 10-30V DC, PNP NO, Connector M12, IP67, Brass Teflon coated, Static, welding-proof



Inductive proximity switches are contact-free sensors. They detect all conductive metals, regardless of whether they move or not. The achievable sensing range of the devices depends on the object material and its dimensions. The vibration-resistant sensors can be approached laterally or frontally. Inductive proximity switches are used for presence detection (e.g. goods carriers), positioning (e.g. dampers), counting (e.g. nuts /bolts), speed detection (e.g. for cog wheels), on conveyor systems (e.g. hose feedings) or distance measurements (e.g. press-in checking) of metallic objects.

Electrical features

Type of switching function	Normally open contact (NO)
Type of electrical connection	Connector M12
Type of switching output	PNP
Rated switching current	200 mA
Correction factor (aluminum)	1
Correction factor (copper)	1
Correction factor (brass)	1
Correction factor (St37)	1
Correction factor (stainl. steel)	1
Short-circuit protection	Yes
No-load current	15 mA
Residual ripple	10 %
Switching distance	3 mm
Switching frequency	2000 Hz
Switching behavior of the output	Static
Voltage drop	2.5 V
Reverse polarity protection	Yes
Operating voltage (DC)	10 - 30 V

Mechanical features

Tightening torque	10 Nm
Alignment of cable entry	axial
Design	Cylinder, screw-thread
Thread length	36 mm
Thread pitch	1 mm
Cable infeed	axial
Length	50 mm
Mechanical mounting condition for sensor	flush
Surface	teflon coated
Degree of protection (IP)	IP67
Active area material of sensor	Plastic (LCP)
Housing material	Brass
Thread dimension	M12
Ambient temperature	-25 - 70 °C

Other features

Welding area	Yes
--------------	-----

Classification

ETIM 8	EC002714 Inductive proximity switch
--------	-------------------------------------

More

IPF Product Group	207 inductive sensors (welding proof)
packaging dimensions	120 x 100 x 15 mm
gross weight	27 g
Customs tariff number	85365019
WEEE number	40951076
OzDS-compliant	Yes
POP-compliant	Yes
Reach-compliant	Yes
RoHS-compliant	Yes

Connection

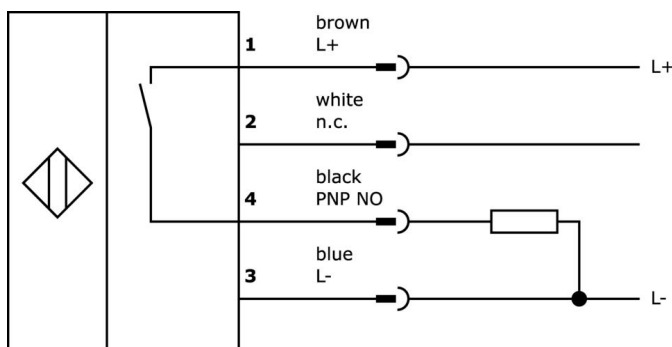

Extract accessories program

VK030F23



Connection cable, 0.3m, M12 socket 4-pin angular, M12 connector 4-pin straight, 4x0. 34mm², PUR (polyurethane), IP67, LED, suitable for trailing chain and torsion resistant, oils and cooling lubricants, welding area, silicone-free

VK030F26



Connection cable, 0.3m, M12 socket 4-pin straight, M12 connector 4-pin straight, 4x0. 34mm², PUR (polyurethane), IP67, LED, suitable for trailing chain and torsion resistant, oils and cooling lubricants, welding area, silicone-free

VK003021



Cable socket, Angular, Suitable for self-assembly, Screw connection, Ø3-6.5mm, 4A, 60V, -25-90°C, M12 Female (socket) 5pin, IP67, PBT

VK003025



Cable socket, Straight, Suitable for self-assembly, Screw connection, Ø3-6.5mm, 4A, 60V, -25-90°C, M12 Female (socket) 5pin, IP67, PBT

VK030F60



Connection cable, 0.3m, M12 socket 3-pin angular, M8 connector 3-pin straight, 3x0. 34mm², PUR (polyurethane), 60V, IP67, suitable for trailing chain and torsion resistant, oils and cooling lubricants, welding area, silicone-free

VK030F64



Connection cable, 0.3m, M12 socket 3-pin straight, M8 connector 3-pin straight, 3x0. 34mm², PUR (polyurethane), 60V, IP67, suitable for trailing chain and torsion resistant, oils and cooling lubricants, welding area, silicone-free

VK003020



Cable socket, angular, self-assembly, screw connection, Ø3-6.5mm, 4A, 240V, -25-90°C, M12 socket 4-pin, IP67, PBT

VK003024



Cable socket, Straight, Suitable for self-assembly, Screw connection, Ø3-6.5mm, 4A, 240V, -25-90°C, M12 Female (socket) 4pin, IP67, PBT

VK030F21



Connection cable, 0.3m, M12 socket 4-pin angular, M12 connector 4-pin straight, 4x0. 34mm², 240V, IP67, suitable for trailing chain and torsion resistant, oils and cooling lubricants, welding area, silicone-free

You can find further accessories on our homepage



Installation

Mounting / installation may only be carried out by a qualified electrician!



Disposal

WEEE number according to § 6 para. 3 ElektroG: 40951076

Safety warnings

/ Before initial operation, please make sure to follow all safety instructions that may be provided in the product information.

/ Never use these devices in applications where the safety of a person depends on their functionality.