

## IY150520

### Inductive sensors • Ring sensors

Sensor inductive, 20x74x35mm, ring 15.1, 10-30V DC, push-pull NC/NO, M12 plug-in connector 4-pin, IP67, polyamide, static/dynamic

- / Static - dynamic switchable
- / LED display
- / plastic housing
- / M12-connector 4-pole



### IO-Link interface Push-pull switching output

Inductive proximity switches are contactless sensors. They detect all conductive metals, regardless of whether they are moving or not. The switching distance that the devices can achieve depends on the object material and its dimensions. The vibration-resistant sensors can be approached laterally or from the front. Inductive proximity switches are used for presence detection (e.g. goods carriers), positioning (e.g. oven flaps), counting (e.g. nuts / screws), speed detection (e.g. on gear wheels), on conveyor systems (e.g. hose feeds) or distance measurement (e.g. press-fit inspection) of metallic objects.

#### Electrical features

Display	LED display
Type of switching function	Normally closed contact/normally open contact
Type of electrical connection	Connector M12
Type of switching output	Push-pull
Rated switching current	100 mA
Readiness delay	300 ms
Setting procedure	Parameterization   Potentiometer
No-load current	30 mA
Max. parts speed	35 m/s
Min. speed	0.1 m/s
Number of pins	4
Switching behavior of the output	Static and dynamic
Voltage drop	2 V
Operating voltage (DC)	10 - 30 V
Output functions	Switching point   Switching behavior (static/dynamic)   Static (factory settings)
ardTEEL_Schutzfunktionen	Reverse polarity protection   Short circuit protection

**Mechanical features**

Design	Cuboid
Width	35 mm
Height	20 mm
Length	73.5 mm
Ring diameter	15.1 mm
Degree of protection (IP)	IP67
Active area material of sensor	Plastic (POM)
Housing material	Polyamide PA
Ambient temperature	-25 - 70 °C

**Optical features**

Resolution, dynamic	0.8 mm
Resolution, static	2 mm

**Other features**

Relative air humidity (non-condensing)	0 - 95 %
IO-Link version	V1.1.3
Reference medium / object	Steel ball

**Classification**

ETIM 8
--------

**More**

IPF Product Group	211 inductive sensors (ring/hose)
packaging dimensions	153 x 153 x 25 mm
gross weight	59 g
Customs tariff number	85365019
WEEE number	40951076
POP-compliant	Yes
Reach-compliant	Yes
RoHS-compliant	Yes

**Connection**

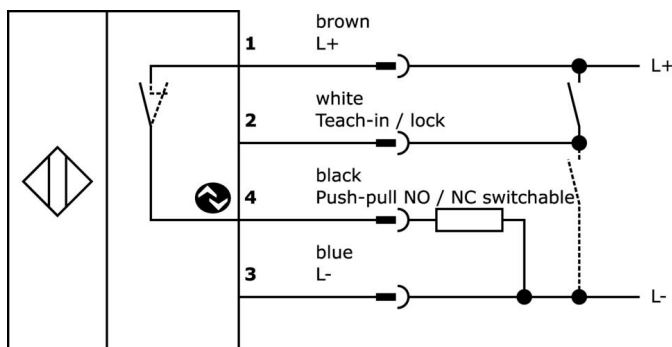

Dimensional drawing

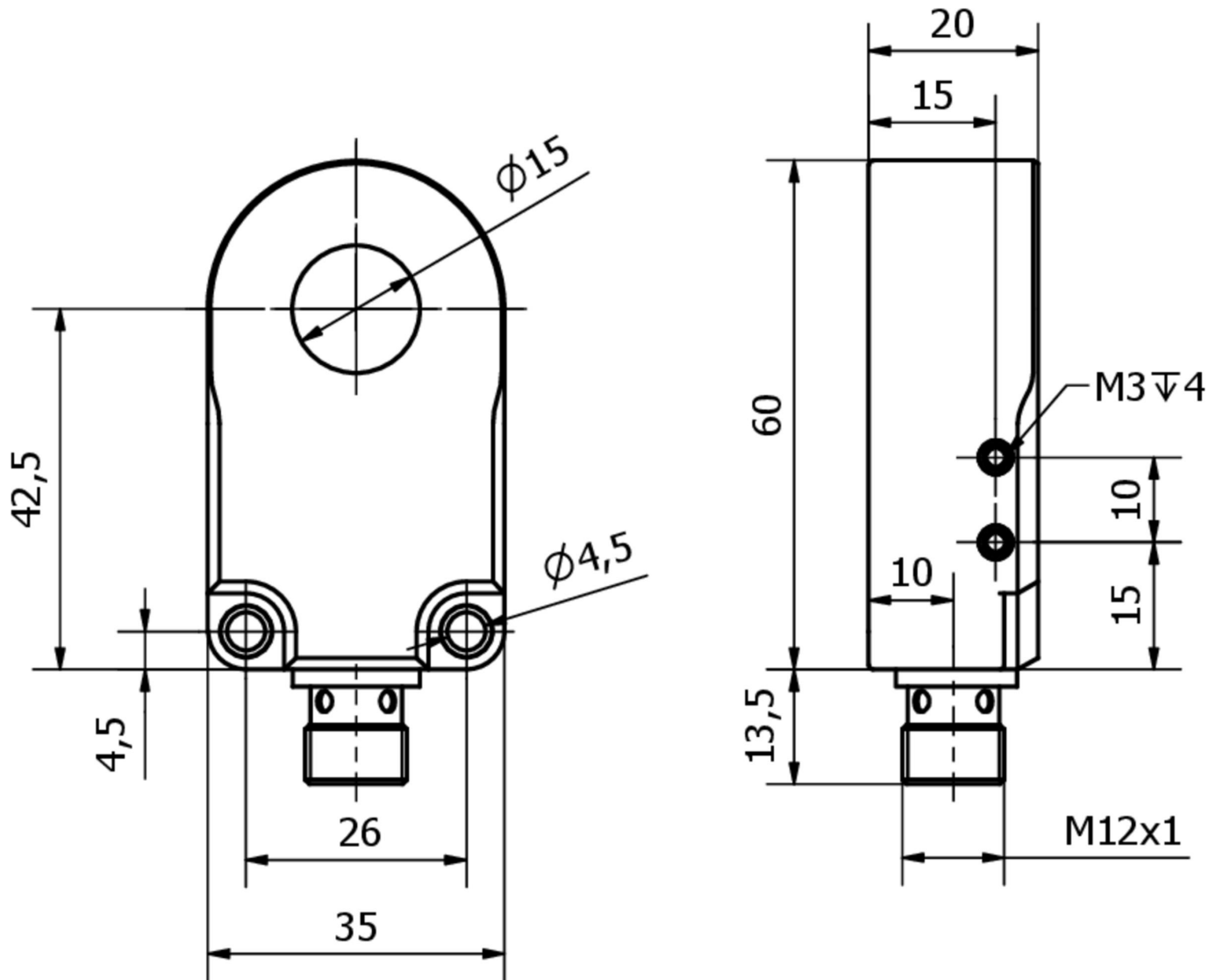

**Extract accessories program****VK200321**

Connection cable, 2m, M12  
Female (socket) 4pin Angular, Free conductor end, 4x0.34mm<sup>2</sup>, PUR (Polyurethane), Ø4.7mm, 250V, -40-90°C, IP67, Suitable for trailing chain and torsion resistant, Oil and cooling lubricants, Welding area, Silicone-free

**VK200325**

Connection cable, 2m, M12  
Female (socket) 4pin Straight, Free conductor end, 4x0.34mm<sup>2</sup>, PUR (Polyurethane), Ø4.7mm, 250V, -40-90°C, IP67, Suitable for trailing chain and torsion resistant, Oil and cooling lubricants, Welding area, Silicone-free

**VK003020**

Cable socket, angular, self-assembly, screw connection, Ø3-6.5mm, 4A, 240V, -25-90°C, M12 socket 4-pin, IP67, PBT

**VK003024**

Cable socket, Straight, Suitable for self-assembly, Screw connection, Ø3-6.5mm, 4A, 240V, -25-90°C, M12 Female (socket) 4pin, IP67, PBT

**AY000181**

accessories sensor, mounting bracket, for attaching a hose to inductive ring sensors IY06 to IY25

You can find further accessories on our homepage

**Installation**

Mounting / installation may only be carried out by a qualified electrician!

**Disposal**

WEEE number according to § 6 para. 3  
ElektroG: 40951076

**Safety warnings**

/ Before initial operation, please make sure to follow all safety instructions that may be provided in the product information.

/ Never use these devices in applications where the safety of a person depends on their functionality.

/ Any software, drivers or IODD files that may be required to operate your device can be downloaded free of charge from our homepage: [www.ipf-electronic.com](http://www.ipf-electronic.com)