

## LT060311

### Fiber optic sensors • Fiber optic glass diffuse-refelction sensor

fiber optic diffuse-reflection sensor, 0.6m, head: Stainless steel 37long Ø4 Ø8, Light exit Axial, conductor: Glassfiber+Silicone, end piece: M18x1 Brass, Sn: 60, -40-180°C, IP67



Fiber optics in combination with the appropriate fiber optic amplifier function as contactless and wear-free position switches that can also be used in harsh environmental conditions. They detect objects independent of their characteristics (e.g., shape, color, surface structure, material). Because the ends and heads of the fiber optics have small dimensions and the fiber optics are flexible, very elegant solutions can be created for detecting objects in places that are difficult to access. Fiber optics can be used without special precautions in potentially explosive areas and in zones with electrical and/or magnetic fields (high-voltage installations, electrical welding equipment) as their function is not thereby affected. Fiber optics are available in versions for implementing the function as through-beam sensor or diffuse reflection sensor.

#### Electrical features

Bending section of the sensing head	0 mm
Bending angle of the sensing head	90 °
Short-circuit protection	No
Sensing head length	37 mm
Switching distance	0 - 60 mm
Reverse polarity protection	No

**Mechanical features**

Type of fiber	Multi
Design	Cylinder plain
Bending radius (flexible)	50 mm
Bending radius (fixed)	25 mm
Sensing head diameter 1	4
Sensing head diameter 2	8
Fiber diameter	2.3 mm
End piece diameter	20 mm
Fiber optic cable diameter	6.7
Sensing head diameter	4 mm
Number of fibers	1
End piece thread pitch	1 mm
Length	600 mm
End piece length	28 mm
Degree of protection (IP)	IP67
Sheathing material	Silicone
End piece material	Brass
Fiber optics core material	Glass
Sensing head material	Stainless steel
Ejection control	Yes
Strong vibration / motion	Yes
Design of the fiber optic connection	screw fitting M18
Thread dimension of the end piece	M18
Ambient temperature	-40 - 180 °C

**Optical features**

Light exit	axial
Nominal operating distance	60 mm

**Other features**

Feeding technology	Yes
ardTE00_Anwendungen	Stanzwerkzeuge starke Verschmutzung

**Classification**

ETIM 8	EC002651 Fiber optic sensor/amplifier
--------	---------------------------------------

**More**

IPF Product Group	150 glass fibers
packaging dimensions	123 x 77 x 25 mm
gross weight	90 g
Customs tariff number	90011090
WEEE number	40951076
Reach-compliant	Yes
RoHS-compliant	Yes

**Dimensional drawing**

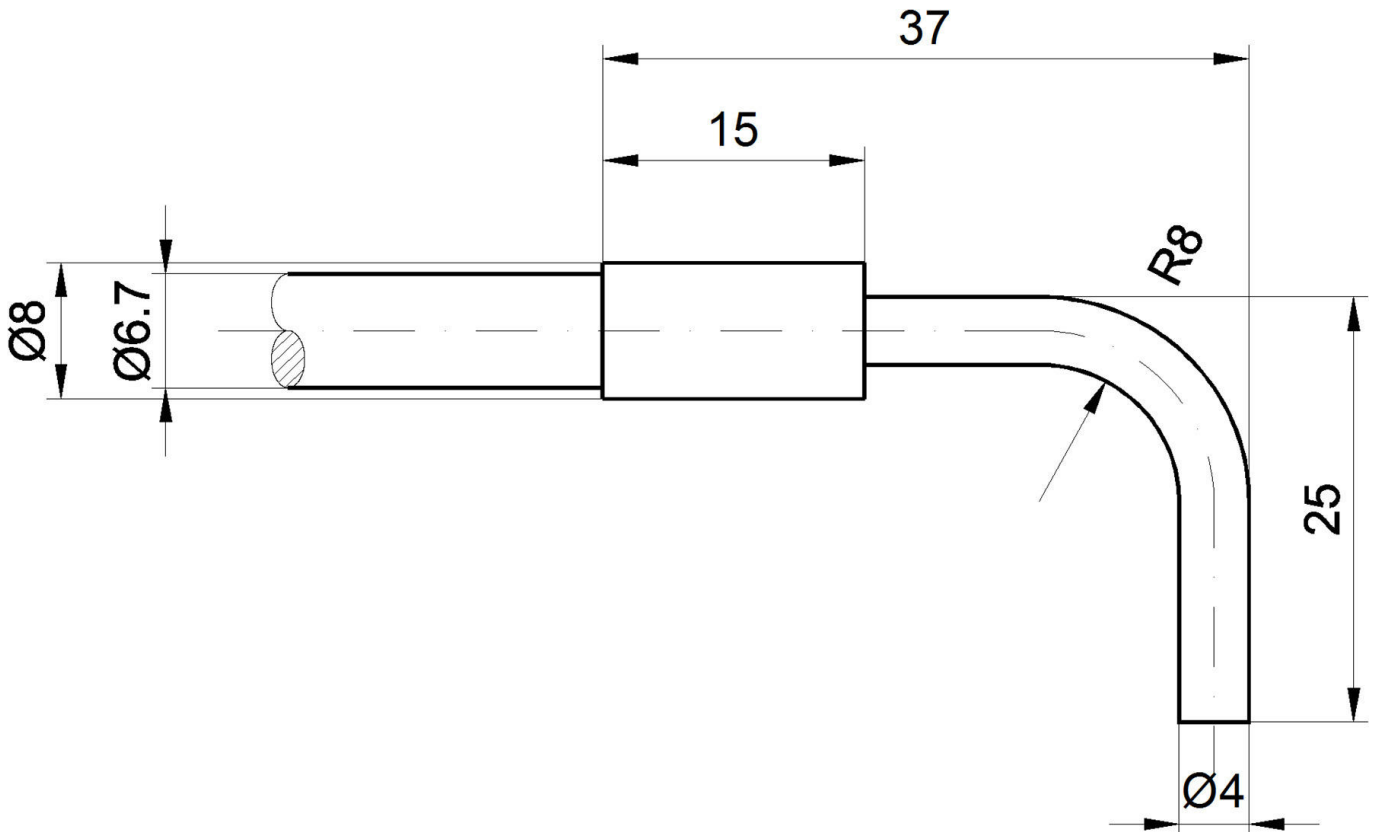

**Extract accessories program**

**OL400321**



fiber optic-amplifier,  
42x84x40mm, 10-35V DC, 1x PNP/  
NPN NC/NO, Connector M12 4pin,  
IP65, Aluminum, Infrared light

**OL400721**



fiber optic-amplifier,  
42x84x40mm, 10-35V DC, 2x PNP/  
NPN NC/NO, Connector M12 4pin,  
IP65, Aluminum, Infrared light,  
Alarm output

You can find further accessories on our homepage



**Installation**

Mounting / installation may only be carried out by a qualified electrician!



**Disposal**

WEEE number according to § 6 para. 3  
ElektroG: 40951076

**Safety warnings**

- / Before initial operation, please make sure to follow all safety instructions that may be provided in the product information.
- / Never use these devices in applications where the safety of a person depends on their functionality.