

OE110170

Optical sensors • Through-beam sensors receivers

Sensor Optical, through-beam sensor receiver, 67x12x8mm, Sn: 2.5m, 10-30V DC, PNP NO, M8 connector, IP65, aluminum anodized/anodized+plastic PC, infrared light



Optical sensors function contactlessly. They detect objects independent of their characteristics (e.g., shape, color, surface structure, material). The basic operating principle is based on the transmission and reception of light. There are three different versions: 1. The through-beam sensor consists of two separate devices, a transmitter and a receiver that are aligned with one another. If the light beam between the two devices is interrupted, the switching output integrated in the receiver changes its status. 2. With the retro-reflective sensor, the transmitter and receiver are located in one device. The emitted light beam is reflected back to the receiver by a reflector that is to be mounted opposite the device. As soon as the light beam is interrupted, the switching output integrated in the device changes its status. 3. With the diffuse reflection sensor, the transmitter and receiver are in one device. The emitted light beam is reflected by the object that is to be detected. As soon as the receiver detects the reflected light, the switching output integrated in the device changes its status.

Electrical features

Response/decay time	2.5 ms
Display	LED display
Type of switching function	Normally open contact (NO)
Type of electrical connection	Connector M8
Type of switching output	PNP
Rated switching current	100 mA
Short-circuit protection	Yes
No-load current	24 mA
No-load current, receiver	24 mA
Switching distance	0 - 2500 mm
Switching frequency	200 Hz
Voltage drop	2 V
Scanning function	Dark switching
Reverse polarity protection	Yes
Decay time	2.5 ms
Operating voltage (DC)	10 - 30 V

Mechanical features

Design	Cuboid
Width	8 mm
Height	67 mm
Length	12 mm
Surface	teflon coated
Degree of protection (IP)	IP65
Active area material of sensor	Plastic (PC)
Housing material	Aluminum
Ambient temperature	-25 - 65 °C

Optical features

Light source	Infrared light
Light beam form	Point
Wavelength of the sensor	880 nm

Classification

ETIM 8	EC002716 Through-beam photoelectric sensor
--------	--

More

IPF Product Group	100 optical sensors
packaging dimensions	123 x 77 x 25 mm
gross weight	20 g
Customs tariff number	85365019
WEEE number	40951076
OzDS-compliant	Yes
POP-compliant	Yes
Reach-compliant	Yes
RoHS-compliant	Yes

Connection

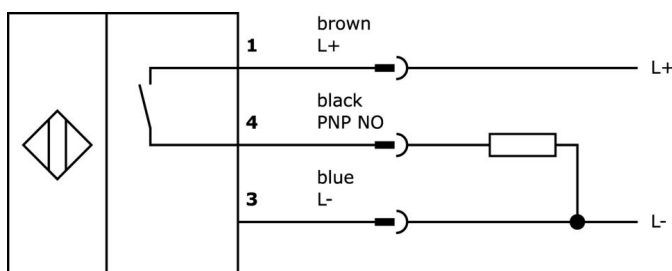

Dimensional drawing

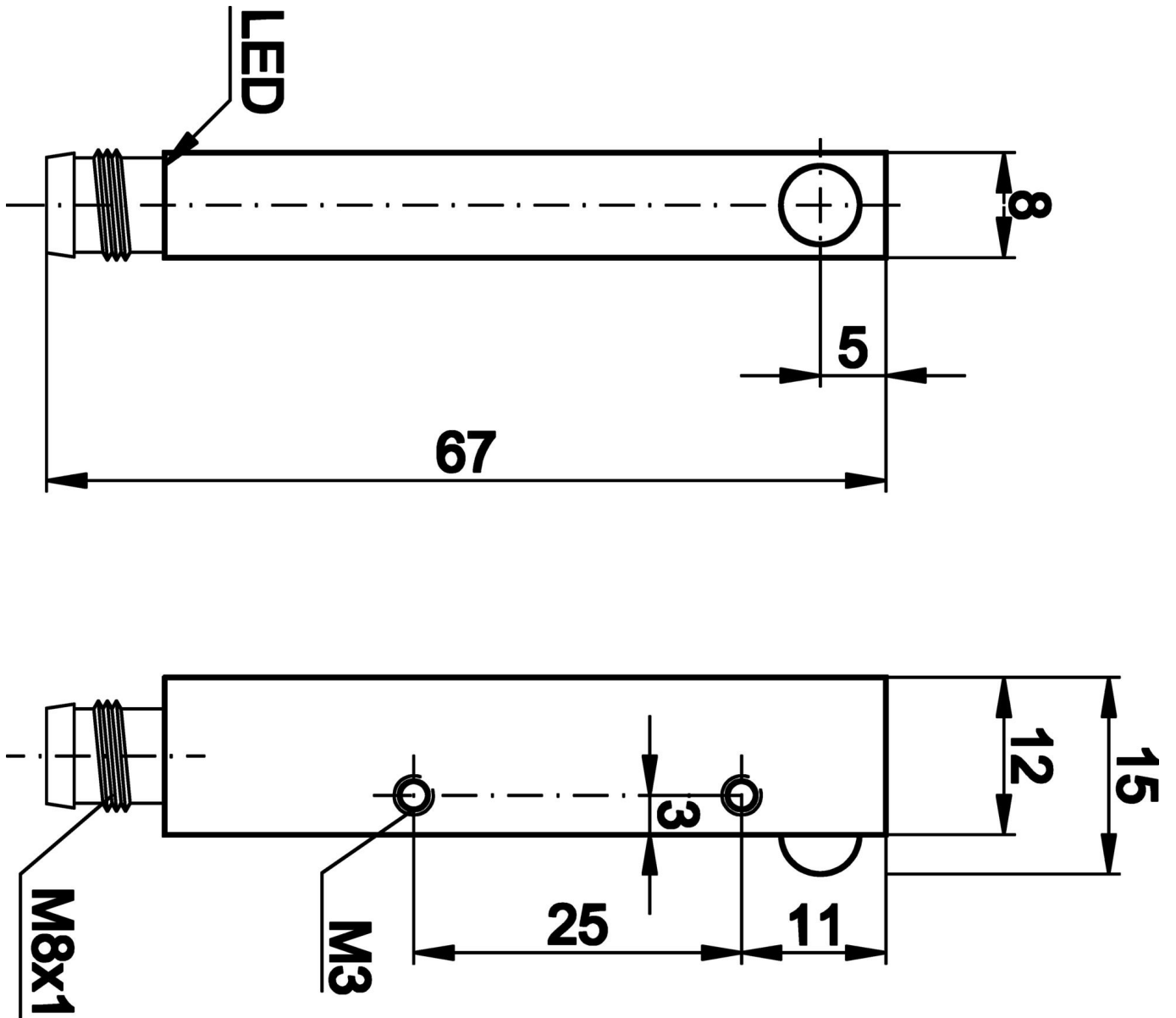

Extract accessories program

VK030F70



Connection cable, 0.3m, M8 socket 3-pin angular, M8 connector 3-pin straight, 3x0. 34mm², PUR (polyurethane), 60V, IP67, suitable for trailing chain and torsion resistant, oils and cooling lubricants, welding area, silicone-free

VK030F74



Connection cable, 0.3m, M8 socket 3-pin straight, M8 connector 3-pin straight, 3x0. 34mm², PUR (polyurethane), 60V, IP67, suitable for trailing chain and torsion resistant, oils and cooling lubricants, welding area, silicone-free

VK030F82



Connection cable, 0.3m, M8 socket 3-pin angular, M12 connector 3-pin straight, 3x0. 34mm², PUR (polyurethane), IP67, LED, suitable for trailing chain and torsion resistant, oils and cooling lubricants, welding area, silicone-free

VK060F82



Connection cable, 0.6m, M8 socket 3-pin angular, M12 connector 3-pin straight, 3x0. 34mm², PUR (polyurethane), IP67, LED, suitable for trailing chain and torsion resistant, oils and cooling lubricants, welding area, silicone-free

VK030F72



Connection cable, 0.3m, M8 socket 3-pin angular, M8 connector 3-pin straight, 3x0. 34mm², PUR (polyurethane), IP67, LED, suitable for trailing chain and torsion resistant, oils and cooling lubricants, welding area, silicone-free

VK060F72



Connection cable, 0.6m, M8 socket 3-pin angular, M8 connector 3-pin straight, 3x0. 34mm², PUR (polyurethane), IP67, LED, suitable for trailing chain and torsion resistant, oils and cooling lubricants, welding area, silicone-free

VK003070



Cable socket, Angular, Suitable for self-assembly, Soldering connection, Ø3.5-5mm, 4A, 60V, -40-85°C, M8 Female (socket) 3pin, IP67, Brass

VK003074



Cable socket, Straight, Suitable for self-assembly, Soldering connection, Ø3.5-5mm, 4A, 60V, -40-85°C, M8 Female (socket) 3pin, IP67, Brass

VK030F80



Connection cable, 0.3m, M8 socket 3-pin angular, M12 connector 3-pin straight, 3x0. 34mm², PUR (polyurethane), 60V, IP67, suitable for trailing chain and torsion resistant, oils and cooling lubricants, welding area, silicone-free

You can find further accessories on our homepage



Installation

Mounting / installation may only be carried out by a qualified electrician!



Disposal

WEEE number according to § 6 para. 3 ElektroG: 40951076

Safety warnings

/ Before initial operation, please make sure to follow all safety instructions that may be provided in the product information.

/ Never use these devices in applications where the safety of a person depends on their functionality.