

## OE136070

### High performance light barriers • Receiver unamplified

High-power photoelectric receiver, 67x12x12mm, standard design, connection to amplifier, M8 connector, IP67, aluminum+plastic



Optical sensors function contactlessly. They detect objects independent of their characteristics (e.g., shape, color, surface structure, material). The basic operating principle is based on the transmission and reception of light. There are three different versions: 1. The through-beam sensor consists of two separate devices, a transmitter and a receiver that are aligned with one another. If the light beam between the two devices is interrupted, the switching output integrated in the receiver changes its status. 2. With the retro-reflective sensor, the transmitter and receiver are located in one device. The emitted light beam is reflected back to the receiver by a reflector that is to be mounted opposite the device. As soon as the light beam is interrupted, the switching output integrated in the device changes its status. 3. With the diffuse reflection sensor, the transmitter and receiver are in one device. The emitted light beam is reflected by the object that is to be detected. As soon as the receiver detects the reflected light, the switching output integrated in the device changes its status.

#### Electrical features

Type of electrical connection	Connector M8
Number of pins	3
Switching distance	0 - 70000 mm
Switching frequency	15 Hz
Connection to amplifier	Yes

#### Mechanical features

Design	Cuboid
Width	12 mm
Receiver design	Normal design
Height	66.8 mm
Storage temperature	-40 - 80 °C
Length	12 mm
Shock resistance	30 g
Degree of protection (IP)	IP67
Vibration resistance	55 Hz
Active area material of sensor	Plastic
Housing material	Aluminum
Ambient temperature	-25 - 60 °C

**Optical features**

Light source	Infrared light
Light beam form	Point
Wavelength of the sensor	880 nm
Angle of beam spread	25 °

**Classification**

ETIM 8	EC002716 Through-beam photoelectric sensor
--------	--

**More**

IPF Product Group	101 high performance through-beam sensors and amplifiers
packaging dimensions	123 x 77 x 25 mm
gross weight	35 g
Customs tariff number	85365019
WEEE number	40951076
Reach-compliant	Yes
RoHS-compliant	Yes

**Connection**

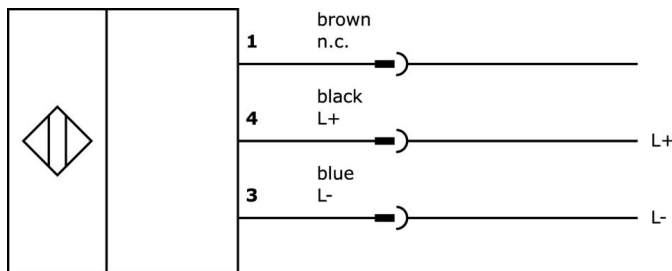

**Dimensional drawing**

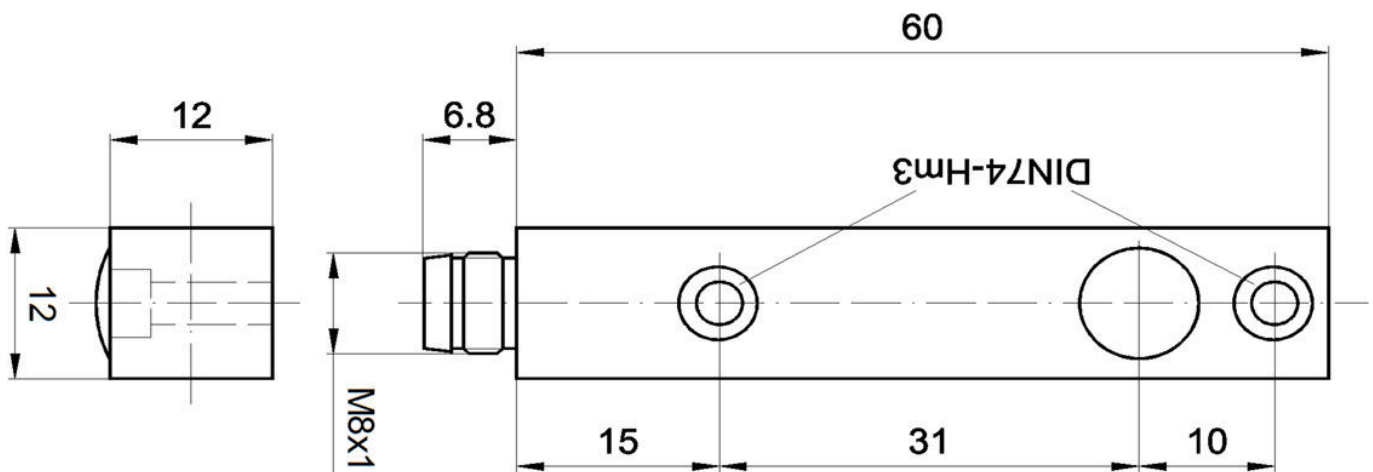

**Extract accessories program**

**VK030F70**



Connection cable, 0.3m, M8 socket 3-pin angular, M8 connector 3-pin straight, 3x0.34mm<sup>2</sup>, PUR (polyurethane), 60V, IP67, suitable for trailing chain and torsion resistant, oils and cooling lubricants, welding area, silicone-free

**VK030F74**



Connection cable, 0.3m, M8 socket 3-pin straight, M8 connector 3-pin straight, 3x0.34mm<sup>2</sup>, PUR (polyurethane), 60V, IP67, suitable for trailing chain and torsion resistant, oils and cooling lubricants, welding area, silicone-free

**OS136070**



High-power photoelectric sensor transmitter, 67x12x12mm, normal power (40mW), 12°, connection to amplifier, M8 3-pin connector, IP67, aluminum+plastic

**VK003070**



Cable socket, Angular, Suitable for self-assembly, Soldering connection, Ø3.5-5mm, 4A, 60V, -40-85°C, M8 Female (socket) 3pin, IP67, Brass

**VK003074**



Cable socket, Straight, Suitable for self-assembly, Soldering connection, Ø3.5-5mm, 4A, 60V, -40-85°C, M8 Female (socket) 3pin, IP67, Brass

**VK030F80**



Connection cable, 0.3m, M8 socket 3-pin angular, M12 connector 3-pin straight, 3x0.34mm<sup>2</sup>, PUR (polyurethane), 60V, IP67, suitable for trailing chain and torsion resistant, oils and cooling lubricants, welding area, silicone-free

**VK030F84**



Connection cable, 0.3m, M8 socket 3-pin straight, M12 connector 3-pin straight, 3x0.34mm<sup>2</sup>, PUR (polyurethane), 60V, IP67, suitable for trailing chain and torsion resistant, oils and cooling lubricants, welding area, silicone-free

**VK200071**



Connection cable, 2m, M8 Female (socket) 3pin Angular, Free conductor end, 3x0.34mm<sup>2</sup>, PUR (Polyurethane), Ø4.3mm, 60V, -40-90°C, IP67, TPU, Suitable for trailing chain and torsion resistant, Oil and cooling lubricants, Welding area, Silicone-free

**VK200075**



Connection cable, 2m, M8 female (socket) 3pin Straight, free conductor end, 3x0.34mm<sup>2</sup>, PUR (Polyurethane), Ø4.3mm, 60V, -30-90°C, IP67, suitable for trailing chain and torsion resistant, oil and cooling lubricants, welding area, Silicone-free

You can find further accessories on our homepage



**Installation**

Mounting / installation may only be carried out by a qualified electrician!



**Disposal**

WEEE number according to § 6 para. 3 ElektroG: 40951076

**Safety warnings**

/ Before initial operation, please make sure to follow all safety instructions that may be provided in the product information.

/ Never use these devices in applications where the safety of a person depends on their functionality.