

OHK00570

Optical sensors • Frame light barriers

Sensor Optical, frame 100x92, 152x130x15mm, static and dynamic, resolution 3mm, 18-30V DC, PNP/NPN NC/NO, M8 plug connector 3-pin, IP67, aluminum+plastic, With time function



Optoelectronics frame light barriers and ring sensors work according to the throughbeam light barrier principle. The housing contains a large number of transmitter and receiver elements that form a light curtain and thus detect and record a wide variety of objects. Application examples for these systems are ejection checks on presses, presence checks and length measurements of wires or pipes.

Electrical features

Response/decay time	0.05 ms
Display	LED display
Type of switching function	Normally closed contact/normally open contact
Type of electrical connection	Connector M8
Type of switching output	Push-pull
Rated switching current	100 mA
Setting procedure	Potentiometer
Pulse stretching	0 - 150 ms
Short-circuit protection	Yes
No-load current	45 mA
Number of pins	3
Reaction time	0.05 ms
Protection class	III
Voltage drop	2 V
Reverse polarity protection	Yes
Supported communication interface	IO-Link
Operating voltage (DC)	18 - 30 V
Time function	Yes
Output functions	Switching point Switching behavior (static/dynamic)

Mechanical features

Design	Cuboid
Constructive design	Two-piece
Width	130 mm
Active zone width	100 mm
Height	15 mm
Active zone height	92 mm
Length	151.5 mm
Frame opening, lengthwise	92 mm
Frame opening, crosswise	100 mm
Degree of protection (IP)	IP67
Active area material of sensor	Plastic
Housing material	Aluminum
With mechanical impact protection	Yes
Ambient temperature	-10 - 60 °C

Optical features

Resolution, dynamic	2.5 mm
Resolution, static	3 mm
Light source	Infrared light
Min. object size	3 mm

Other features

IO-Link version	V1.1.3
-----------------	--------

Classification

ETIM 8	
--------	--

More

IPF Product Group	112 frame light barriers
packaging dimensions	315 x 190 x 40 mm
gross weight	426 g
Customs tariff number	85365019
WEEE number	40951076
POP-compliant	Yes
Reach-compliant	Yes
RoHS-compliant	Yes

Connection

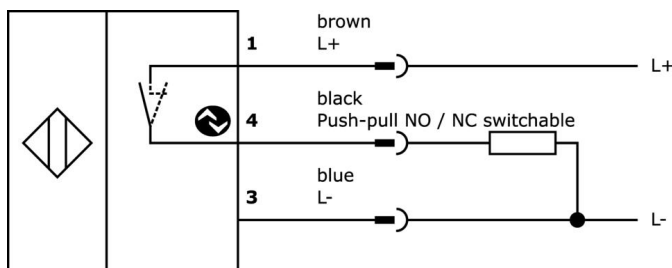

Dimensional drawing

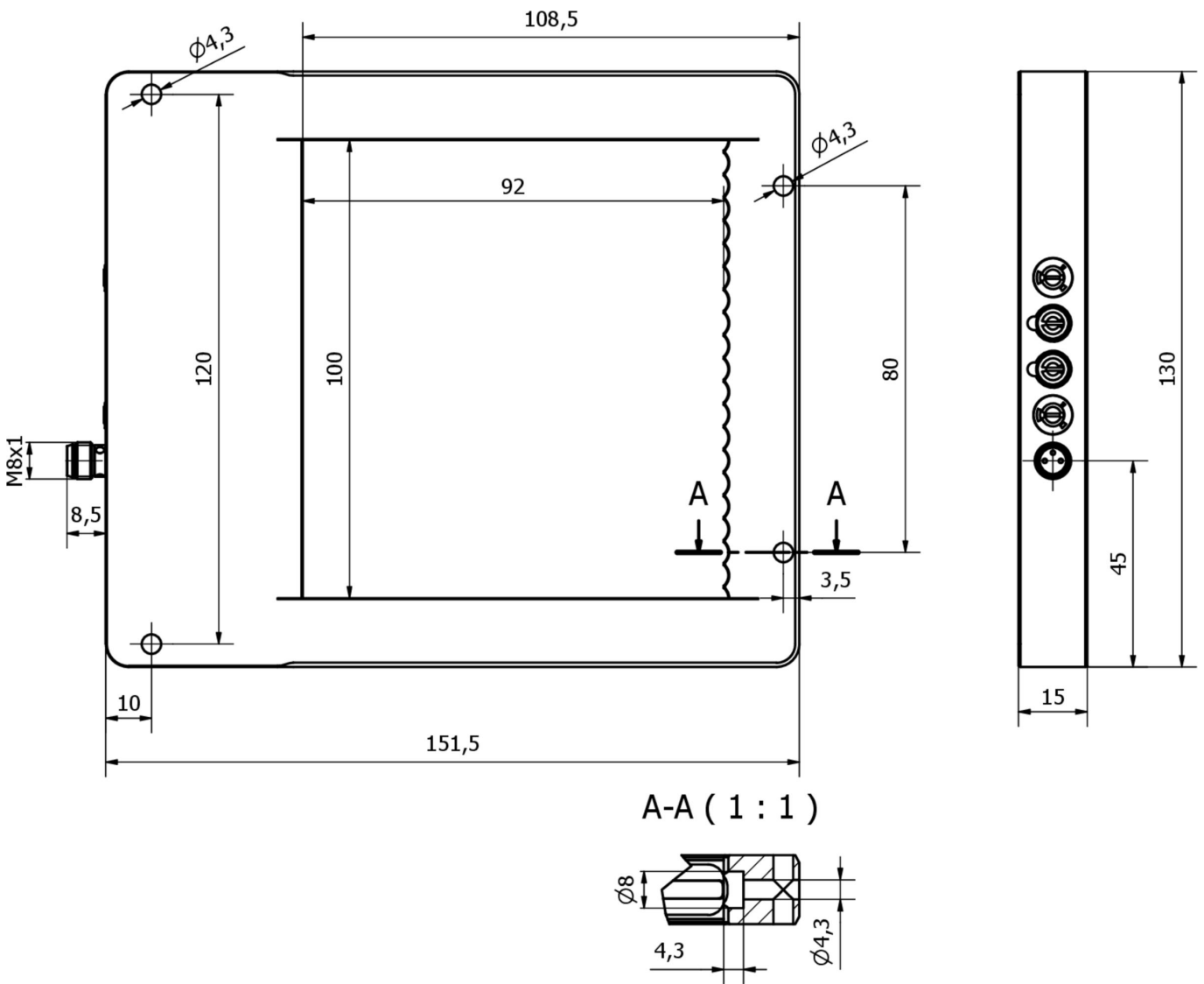

Extract accessories program

VK030F82



Connection cable, 0.3m, M8 socket 3-pin angular, M12 connector 3-pin straight, 3x0.34mm², PUR (polyurethane), IP67, LED, suitable for trailing chain and torsion resistant, oils and cooling lubricants, welding area, silicone-free

VK060F82



Connection cable, 0.6m, M8 socket 3-pin angular, M12 connector 3-pin straight, 3x0.34mm², PUR (polyurethane), IP67, LED, suitable for trailing chain and torsion resistant, oils and cooling lubricants, welding area, silicone-free

VK200271



Connection cable, 2m, M8 Female (socket) 3pin Angular, Free conductor end, 3x0.34mm², PUR (Polyurethane), Ø4.3mm, -30-90°C, IP67, With LED display, Suitable for trailing chain and torsion resistant, Oil and cooling lubricants, Welding area, Silico...

VK500271



Connection cable, 5m, M8 Female (socket) 3pin Angular, Free conductor end 3pin, 3x0.34mm², PUR (Polyurethane), Ø4.3mm, -30-90°C, IP67, With LED display, Suitable for trailing chain and torsion resistant, Oil and cooling lubricants, Welding area, S...

VK000036



Adaption, M8 Female (socket) 3pin Straight, M12 Male (connector) 3pin Straight, 24V, -25-85°C, IP67, Oil and cooling lubricants, Welding area

VK003070



Cable socket, Angular, Suitable for self-assembly, Soldering connection, Ø3.5-5mm, 4A, 60V, -40-85°C, M8 Female (socket) 3pin, IP67, Brass

VK003074



Cable socket, Straight, Suitable for self-assembly, Soldering connection, Ø3.5-5mm, 4A, 60V, -40-85°C, M8 Female (socket) 3pin, IP67, Brass

VK030F72



Connection cable, 0.3m, M8 socket 3-pin angular, M12 connector 3-pin straight, 3x0.34mm², PUR (polyurethane), IP67, LED, suitable for trailing chain and torsion resistant, oils and cooling lubricants, welding area, silicone-free

VK060F72



Connection cable, 0.6m, M8 socket 3-pin angular, M12 connector 3-pin straight, 3x0.34mm², PUR (polyurethane), IP67, LED, suitable for trailing chain and torsion resistant, oils and cooling lubricants, welding area, silicone-free

You can find further accessories on our homepage



Installation

Mounting / installation may only be carried out by a qualified electrician!



Disposal

WEEE number according to § 6 para. 3 ElektroG: 40951076

Safety warnings

/ Before initial operation, please make sure to follow all safety instructions that may be provided in the product information.

/ Never use these devices in applications where the safety of a person depends on their functionality.

/ Any software, drivers or IODD files that may be required to operate your device can be downloaded free of charge from our homepage: www.ipf-electronic.com