

OI98C525

Temperature sensors • contactless measurement (infrared)

Sensor Optical, infrared, Ø14mm, -40-900°C, 22:1, 8-36V DC, NO, 0/4-20mA, 0/5-10V, terminal, IP65, V4A, cable length of sensor head 3m



Electrical features

Response/decay time	150 ms
Display	LCD display LED display
Type of switching function	Normally open contact (NO)
Type of alarm output	PNP
Type of analog output	0 - 10V 0 - 20mA 0 - 5V 4 - 20mA
Type of electrical connection	Clamped terminal connection
Type of thermocouple	Simulated (J or K)
Rated switching current	50 mA
Setting procedure	Application software Parameterization
No-load current	100 mA
Measuring range, temperature	-40 - 900 °C
Relative repeat accuracy	0.5 %
Switching function of the alarm output	Normally open contact (NO)
Temperature drift over entire measuring range	0.05 %
Supported communication interface	Optional
Operating voltage (DC)	8 - 36 V
Data logging possible	Yes
Output functions	Switching point

Mechanical features

Design	Cuboid
Operating temperature of the measuring head	-20 - 180 °C
Diameter	14 mm
Thread length	10 mm
Thread pitch	1 mm
Cable length of measuring head	3 m
Length	32 mm
Degree of protection (IP)	IP65
Housing material	Stainless steel 1.4571
Height of the amplifier	30 mm
Length of the amplifier	120 mm
Width of the amplifier	70 mm
Thread dimension	M12

Optical features

Spectral sensitivity	8 - 14 µm
Ratio (D:S)	22:1

Classification

ETIM 8	EC000601 Measuring device for temperature and climate
--------	---

More

IPF Product Group	310 temperature sensors
packaging dimensions	210 x 145 x 75 mm
gross weight	580 g
Customs tariff number	90251900
WEEE number	40951076
Reach-compliant	Yes
RoHS-compliant	Yes

Connection

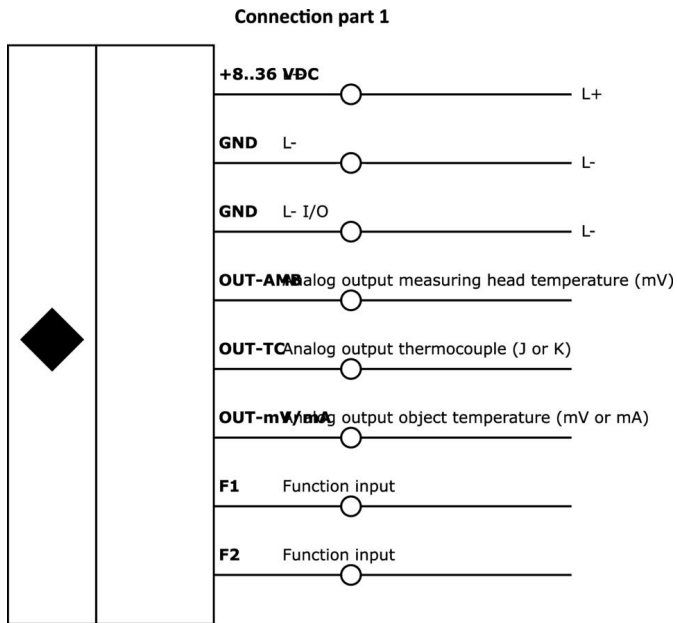

Dimensional drawing

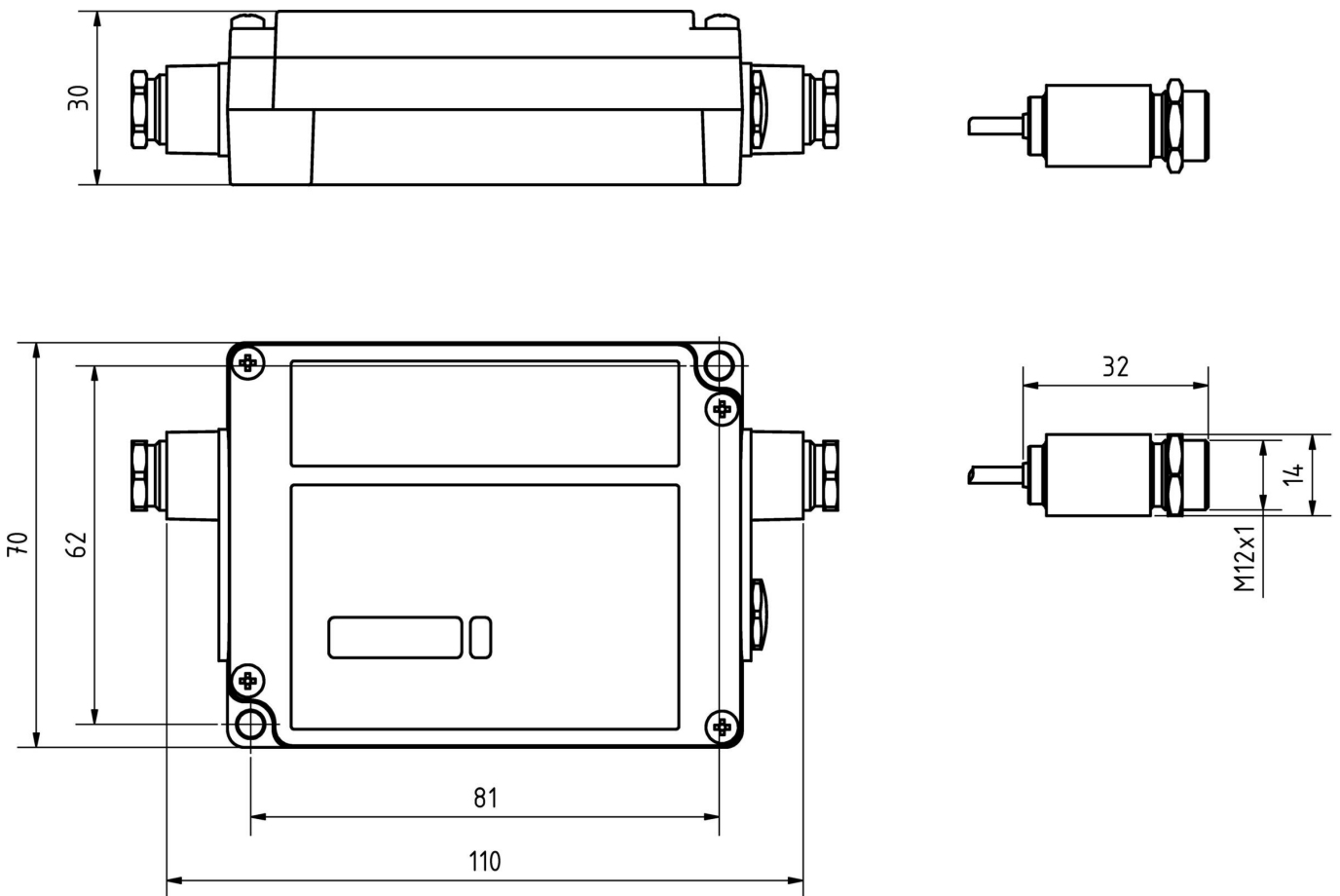

Extract accessories program

AO98C526



accessories optical, Mounting rail adapter, 74x93x2mm, Straight, DIN rail (top hat rail) 35 mm, Metal, Snap connection

AO98A998



You can find further accessories on our homepage



Installation

Mounting / installation may only be carried out by a qualified electrician!



Disposal

WEEE number according to § 6 para. 3
ElektroG: 40951076

Safety warnings

- / Before initial operation, please make sure to follow all safety instructions that may be provided in the product information.
- / Never use these devices in applications where the safety of a person depends on their functionality.