

PS130070

Laser sensors • Through-beam sensors transmitters

Sensor laser, through-beam sensor transmitter, 64x14x12mm, aperture Ø0.5mm, Sn: 1.5m, 12-32V DC, M8 connector 3-pin, IP67, brass nickel-plated (n-pltd) + glass, laser diode, red light



Optical sensors function contactlessly. They detect objects independent of their characteristics (e.g., shape, color, surface structure, material). The basic operating principle is based on the transmission and reception of light. There are three different versions: 1. The through-beam sensor consists of two separate devices, a transmitter and a receiver that are aligned with one another. If the light beam between the two devices is interrupted, the switching output integrated in the receiver changes its status. 2. With the retro-reflective sensor, the transmitter and receiver are located in one device. The emitted light beam is reflected back to the receiver by a reflector that is to be mounted opposite the device. As soon as the light beam is interrupted, the switching output integrated in the device changes its status. 3. With the diffuse reflection sensor, the transmitter and receiver are in one device. The emitted light beam is reflected by the object that is to be detected. As soon as the receiver detects the reflected light, the switching output integrated in the device changes its status.

Electrical features

Display	LED display
Type of electrical connection	Connector M8
Laser power	1 mW
No-load current	60 mA
No-load current, transmitter	60 mA
Number of pins	3
Switching distance	0 - 1500 mm
Reverse polarity protection	Yes
Operating voltage (DC)	12 - 32 V

Mechanical features

Design	Cuboid
Aperture diameter	0.5 mm
Width	12 mm
Height	64 mm
Storage temperature	85 °C
Length	14 mm
Surface	nickel-plated
Degree of protection (IP)	IP67
Active area material of sensor	glass
Housing material	Brass
Ambient temperature	-20 - 50 °C

Optical features

Laser class	Class 1
Light source	Laser diode, red light
Light beam form	Point
Wavelength of the sensor	670 nm
Light spot diameter at focal point	0.25 mm

Other features

Features	with test input
----------	-----------------

Classification

ETIM 8	EC002716 Through-beam photoelectric sensor
--------	--

More

IPF Product Group	160 laser sensor
packaging dimensions	123 x 77 x 25 mm
gross weight	70 g
Customs tariff number	85365019
WEEE number	40951076
POP-compliant	Yes
Reach-compliant	Yes
RoHS-compliant	Yes
MTTF	3 year(s)

Connection

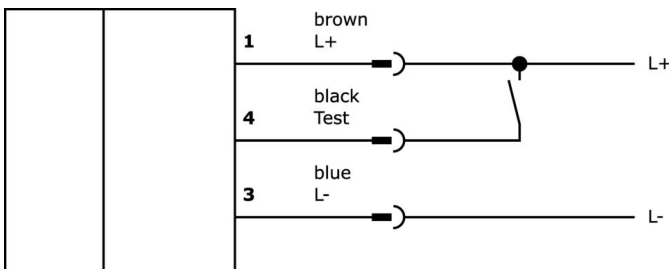

Dimensional drawing

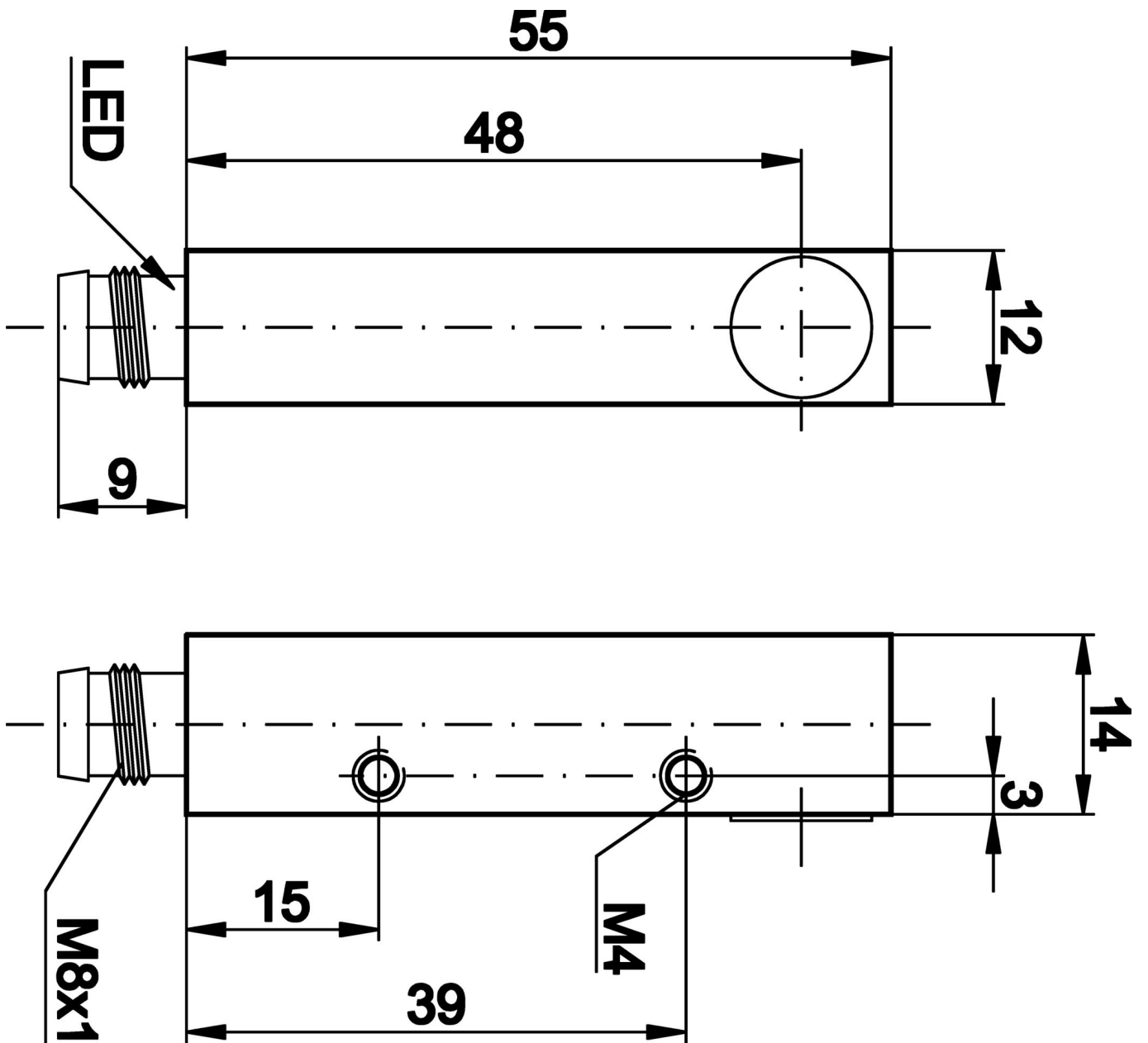

Extract accessories program

VK030F70



Connection cable, 0.3m, M8 socket 3-pin angular, M8 connector 3-pin straight, 3x0.34mm², PUR (polyurethane), 60V, IP67, suitable for trailing chain and torsion resistant, oils and cooling lubricants, welding area, silicone-free

VK030F74



Connection cable, 0.3m, M8 socket 3-pin straight, M8 connector 3-pin straight, 3x0.34mm², PUR (polyurethane), 60V, IP67, suitable for trailing chain and torsion resistant, oils and cooling lubricants, welding area, silicone-free

VK200071



Connection cable, 2m, M8 Female (socket) 3pin Angular, Free conductor end, 3x0.34mm², PUR (Polyurethane), Ø4.3mm, 60V, -40-90°C, IP67, TPU, Suitable for trailing chain and torsion resistant, Oil and cooling lubricants, Welding area, Silicone-free

VK200075



Connection cable, 2m, M8 female (socket) 3pin Straight, free conductor end, 3x0.34mm², PUR (Polyurethane), Ø4.3mm, 60V, -30-90°C, IP67, suitable for trailing chain and torsion resistant, oil and cooling lubricants, welding area, Silicone-free

VK003070



Cable socket, Angular, Suitable for self-assembly, Soldering connection, Ø3.5-5mm, 4A, 60V, -40-85°C, M8 Female (socket) 3pin, IP67, Brass

VK003074



Cable socket, Straight, Suitable for self-assembly, Soldering connection, Ø3.5-5mm, 4A, 60V, -40-85°C, M8 Female (socket) 3pin, IP67, Brass

VK030F80



Connection cable, 0.3m, M8 socket 3-pin angular, M12 connector 3-pin straight, 3x0.34mm², PUR (polyurethane), 60V, IP67, suitable for trailing chain and torsion resistant, oils and cooling lubricants, welding area, silicone-free

VK030F84



Connection cable, 0.3m, M8 socket 3-pin straight, M12 connector 3-pin straight, 3x0.34mm², PUR (polyurethane), 60V, IP67, suitable for trailing chain and torsion resistant, oils and cooling lubricants, welding area, silicone-free

VK030F72



Connection cable, 0.3m, M8 socket 3-pin angular, M8 connector 3-pin straight, 3x0.34mm², PUR (polyurethane), IP67, LED, suitable for trailing chain and torsion resistant, oils and cooling lubricants, welding area, silicone-free

You can find further accessories on our homepage



Installation

Mounting / installation may only be carried out by a qualified electrician!



Disposal

WEEE number according to § 6 para. 3 ElektroG: 40951076

Safety warnings

/ Before initial operation, please make sure to follow all safety instructions that may be provided in the product information.

/ Never use these devices in applications where the safety of a person depends on their functionality.