

SL550707

Flow sensors • Sensors for air

Sensor flow, air, calorimetric, 80x61x30mm, G 1/2 "mm, 12-24V DC, cable tail 2m PVC, plastic PC, pressure resistance 15bar, 2-500l/min, with LCD display, parameterization, IP40, integrated pressure sensor



LCD display integrated pressure sensor

The function of the flow sensor is based on the calorimetric principle. The sensor is heated by a few degrees Celsius from the inside in relation to the flow medium into which it projects. If the medium flows, the heat generated in the sensor is dissipated by the medium. The temperature generated in the sensor is measured and compared with the temperature of the medium, which is also measured. The flow condition for each medium can be derived from the temperature difference obtained. Applications for these sensors include monitoring cooling systems, ventilation systems, dry running of pumps and monitoring the presence of liquid or gas flows.

Electrical features

Number of digital inputs	1
Number of switching outputs	2
Display	LCD display
Type of switching function	Programmable/configurable
Type of analog output	4 - 20mA
Type of electrical connection	Cable
Type of switching output	PNP
Rated switching current	125 mA
Setting procedure	Parameterization
Short-circuit protection	Yes
Measuring range pressure	0 - 10 bar
Reverse polarity protection	Yes
Measurement principle	calorimetric
Operating voltage (DC)	12 - 24 V
Number of analog output channels	1
ardSOCA_ElektrischerAnschluss	Cable tail 2m
ardTEEL_Linearitaet	±3% of the measuring range
ardTEEL_GarantierterMessbereichBeiDruck	0 - 100% of measuring range
ardTEEL_GarantierterMessbereichBeiStrömung	2 - 100% of the measuring range
ardTEEL_GenauigkeitAnalogausgangBeiDruck	±2.5% of the measuring range
ardTEEL_GenauigkeitAnalogausgangStrömung	±5% of measuring range
ardTEEL_GenauigkeitDerAnzeigeBeiDruck	±2% of the measuring range
ardTEEL_GenauigkeitDerAnzeigeBeiStrömung	±3% of the measuring range
ardTEEL_WiederholgenauigkeitBeiDruck	±0.2% of the measuring range
ardTEEL_WiederholgenauigkeitBeiStrömung	±1% of the measuring range (±2% with a reaction time of 50ms)

Mechanical features

Number of cores	6
Wire cross section	0,15 mm ²
Type of process connection	G1/2 inch
Design	Cuboid, compact
Width	30 mm
Pressure resistance	15 bar
Height	61.65 mm
Cable length	2 m
Storage temperature	-10 - 60 °C
Length	80 mm
Medium temperature	0 - 50 °C
Degree of protection (IP)	IP40
Housing material	Plastic
Sensing element material	Aluminum
Measuring range flow volume	2 - 500 l/min
Ambient temperature	0 - 50 °C
ardSOCA_Abmessungen	80x30x61,65mm
ardTEME_Stroemungsrichtung	Unidirectional
Line diameter	4 mm

Other features

Relative air humidity (non-condensing)	35 - 85 %
Reference medium / object	Air
ardTE00_Anwendungen	Pneumatik-Anwendungen

Classification

ETIM 8	
--------	--

More

IPF Product Group	300 flow sensors
packaging dimensions	121 x 76 x 50 mm
gross weight	237 g
Customs tariff number	90268020
WEEE number	40951076
Reach-compliant	Yes
RoHS-compliant	Yes

Connection

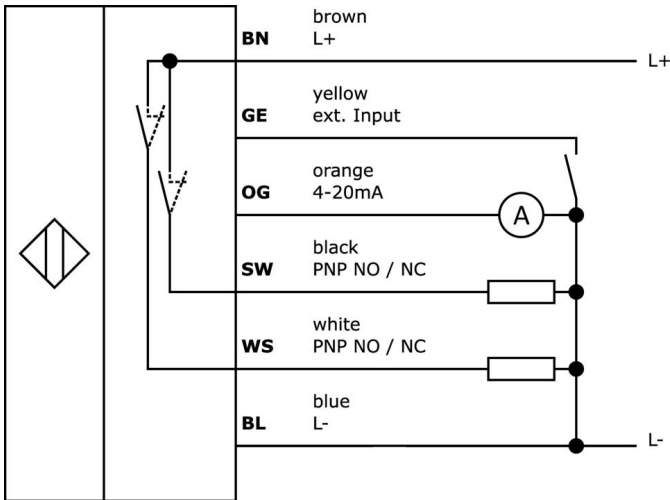

Dimensional drawing

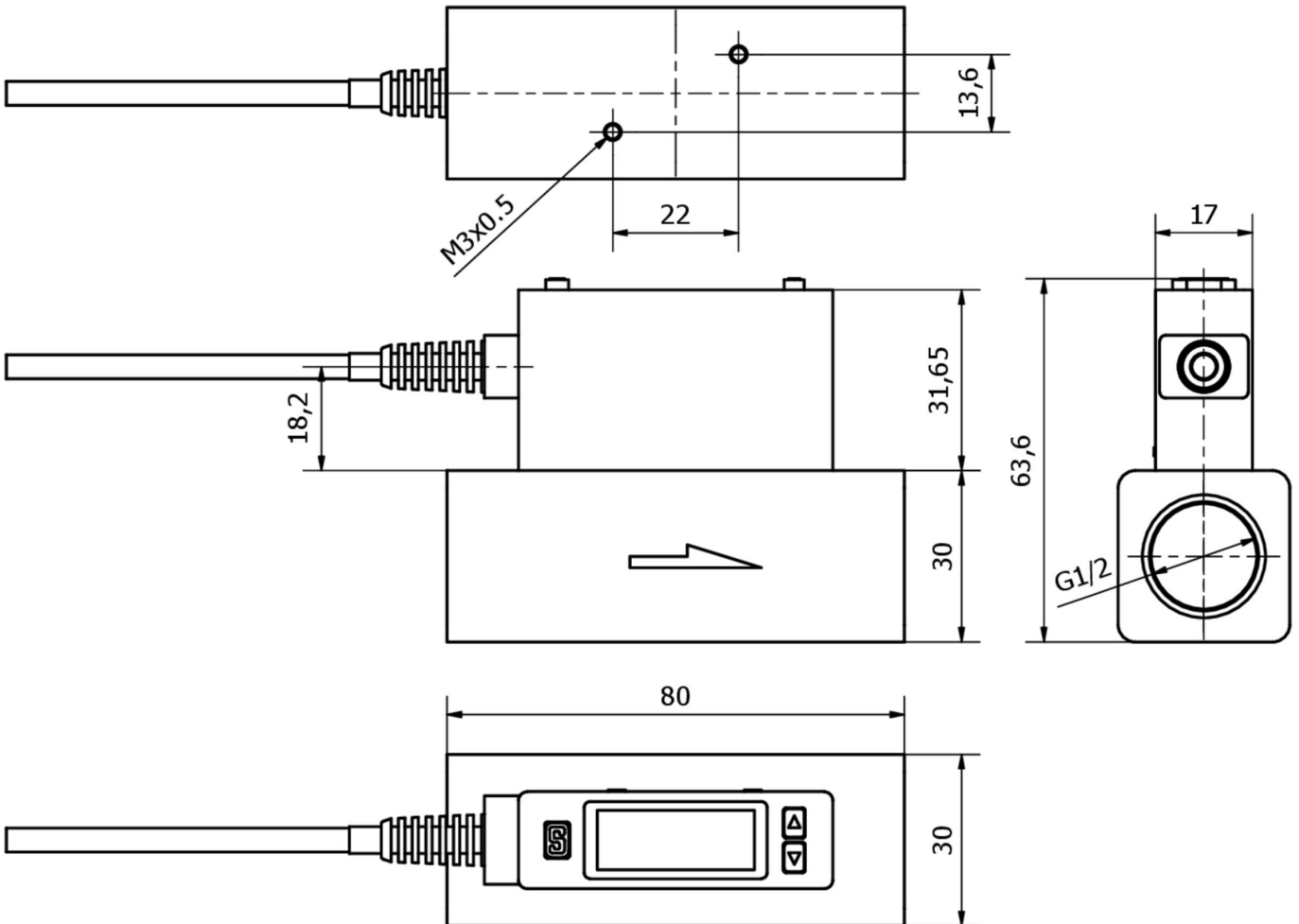

Extract accessories program**VK00382H**

Cable connector, Straight, Suitable for self-assembly, Screw connection, Ø3-6.5mm, 2A, 30V, -25-85°C, M12 Male (connector) 8pin, IP67, PBT

VK00302H

Cable connector, straight, self-assembly, screw connection, Ø4-8mm, 2A, 30V, -30-80°C, M12 connector 8pin, IP67

AS000023

Accessories Holder, 50x32x5mm, stainless steel

You can find further accessories on our homepage

**Installation**

Mounting / installation may only be carried out by a qualified electrician!

**Disposal**

WEEE number according to § 6 para. 3 ElektroG: 40951076

Safety warnings

- / Before initial operation, please make sure to follow all safety instructions that may be provided in the product information.
- / Never use these devices in applications where the safety of a person depends on their functionality.