

VD580515

Encoder • Incremental

Encoder, Ø58mm 60long, solid shaft 6mm, 500 pulses, 4.75-30V DC, -25-85°C, push-pull, plug connector M23 12-pin, IP54, aluminum



An encoder or rotary encoder is a device that converts a rotary movement into a digital output signal that can be processed via downstream evaluation electronics. Our encoders all work on the principle of optical scanning. Inside the device there is an impulse disc on which, depending on the encoder, there is a unique (absolute) or repeating (incremental) line graduation that is scanned by an optical system. Turning the encoder shaft causes the impulse disc to rotate, which results in a corresponding scanning signal from the optical system. This is then converted into encoder-specific output signals by integrated electronics (e.g. multiturn, RS422, etc.). Shaft couplings, resilient base (for mounting brackets or flanges) are used for professional mounting in numerous applications. In addition, the encoder shaft can be fitted with measuring wheels or pinions in various versions and sizes. Typical application examples include angular measurement on bending machines, length measurement on conveyor systems or speed measurement on winding systems.

Electrical features

Type of electrical connection	Connector M23
Type of switching output	Push-pull
Rated switching current	20 mA
Increments per revolution	500
No-load current	30 mA
Shaft length	10
Number of pins	12
Switching frequency	150000 Hz
Signal outputs	A+B+0(+inverted)
Measurement principle	Optical
Operating voltage (DC)	4,75 - 30 V
ardTEEL_Schutzfunktionen	Reverse polarity protection Short circuit protection

Mechanical features

Start-up torque	0.015
Type of encoder shaft	Full shaft
Axial load capacity of shaft	40 N
Encoder size	58
Diameter	58 mm
Shaft diameter	6 mm
Flange	Clamping flange
Cable infeed	axial
Length	60 mm
Max. rotation speed	10000 upm
Radial load capacity of the shaft	40 N
Shock resistance, acceleration	200 g
Shock resistance, pulse time	6 ms
Degree of protection (IP)	IP54
Moment of inertia	14.5 gcm ²
Vibration resistance, acceleration	10 g
Flange material	Aluminum
Housing material	Aluminum
Vibration resistance Frequency	16 - 2000 Hz
Ambient temperature	-25 - 85 °C

Other features

Relative air humidity (non-condensing)	0 - 95 %
--	----------

Classification

ETIM 8	EC001486 Rotary encoder
--------	-------------------------

More

IPF Product Group	520 encoders
packaging dimensions	210 x 138 x 95 mm
gross weight	410 g
Customs tariff number	90318020
WEEE number	40951076
OzDS-compliant	Yes
POP-compliant	Yes
Reach-compliant	Yes
RoHS-compliant	Yes

Connection

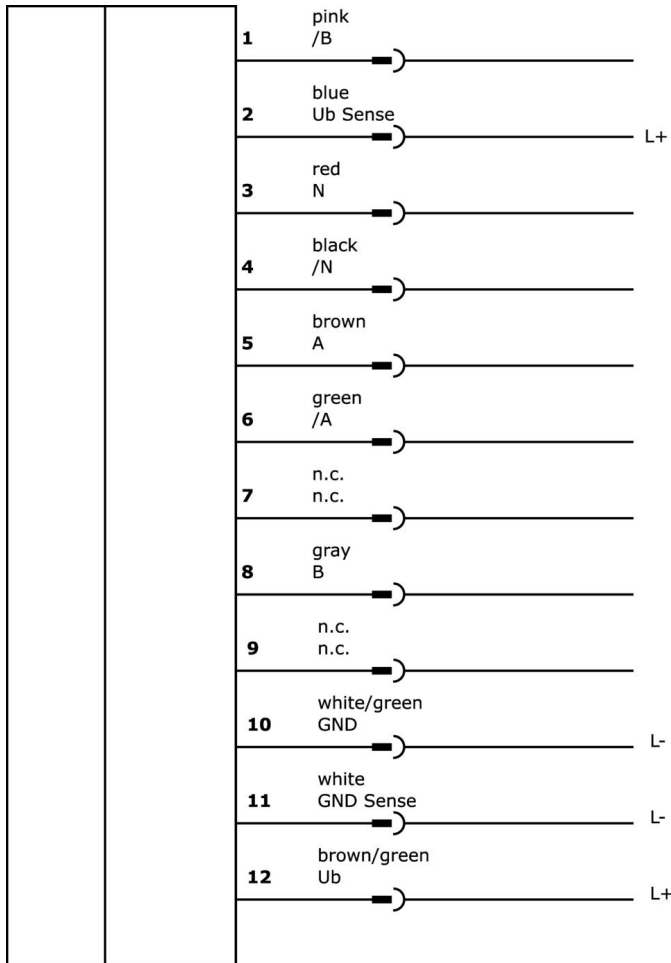

Extract accessories program

AV000029



accessories, Mounting angle bracket, 80x40x90mm, Angle, Aluminum

AV000021



accessories rotary encoder, Cable socket, Straight, Suitable for self-assembly, Soldering connection, Ø5.8-6.2mm, 30A, -40-105°C, M23 Female (socket) 12pin

AV000023



accessories, Connection cable, 2m, M23 Female (socket) 12pin Straight, Free conductor end, 10wire, Metal, Shielded

AV000032



accessories miscellaneous, Helix coupling for encoder, Ø25mm 32long, Aluminum

AV000034



accessories miscellaneous, Measuring wheel, 12mm wide, Plastic

You can find further accessories on our homepage



Installation

Mounting / installation may only be carried out by a qualified electrician!



Disposal

WEEE number according to § 6 para. 3 ElektroG: 40951076

Safety warnings

- / Before initial operation, please make sure to follow all safety instructions that may be provided in the product information.
- / Never use these devices in applications where the safety of a person depends on their functionality.