

VK150F21

Connection technology • Cable sockets / connectors pre-assembled on two sides

Connection cable, 1.5m, M12 socket 4-pin angular, M12 connector 4-pin straight, 4x0.34mm², PUR (polyurethane), 240V, IP67, suitable for trailing chain and torsion resistant, oils and cooling lubricants, welding area, silicone-free



This connection cable has pre-wired connections on both sides. It can be used to cost-effectively integrate end devices with a plug connection via a distribution terminal or a logic module.

Electrical features

Type of plug-in contact, A connection	Female (socket)
Type of plug-in contact, B connection	Male (connector)
Type of A electrical connection	M12
Type of B electrical connection	M12
Number of pins of A connection	4
Number of pins of B connection	4
Operating voltage (AC 50Hz)	240 V
Operating voltage (DC)	240 V

Mechanical features

Number of cores	4
Wire assembly	42 x 0.1mm
Conductor cross-section	0.34 mm ²
Cable length	1.5 m
Cable infeed of A connection	angular
Cable infeed of B connection	straight
Maximum tightening torque of connection A	1 Nm
Maximum tightening torque of connection B	1 Nm
bending cycles	5 million cycles
Degree of protection (IP)	IP67
Torsion cycles	+/-360°/m, ≥ 2 million cycles
Material of cable sheath	Plastic (PUR)
Perm. ambient temperature of cable, fixed cable	-25 - 80 °C
Suitable for trailing chain	Yes

Other features

Flame retardant	in accordance with EN 60332-2-2
Halogen-free	Yes
Hydrolysis-proof	Yes
Free of LABS	Yes
Ozone and UV-resistant	Yes
Suitable for trailing chain and torsion resistant	Yes
Welding area	Yes
Silicone-free	Yes
Oil and cooling lubricants	Yes

Classification

ETIM 8	EC001855 Assembled sensor-actuator cable
--------	--

More

IPF Product Group	851 cable sockets / connectors (both side ready made)
packaging dimensions	160 x 160 x 15 mm
gross weight	70 g
Customs tariff number	85444290
WEEE number	40951076
OzDS-compliant	Yes
POP-compliant	Yes
Reach-compliant	Yes
RoHS-compliant	Yes

Connection

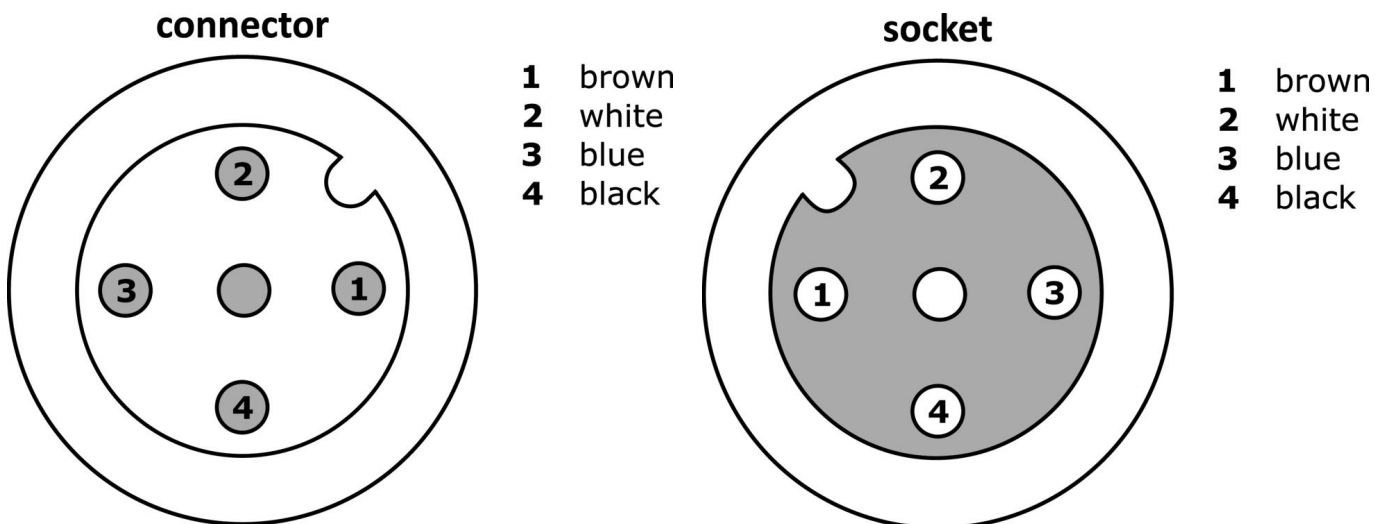

Dimensional drawing

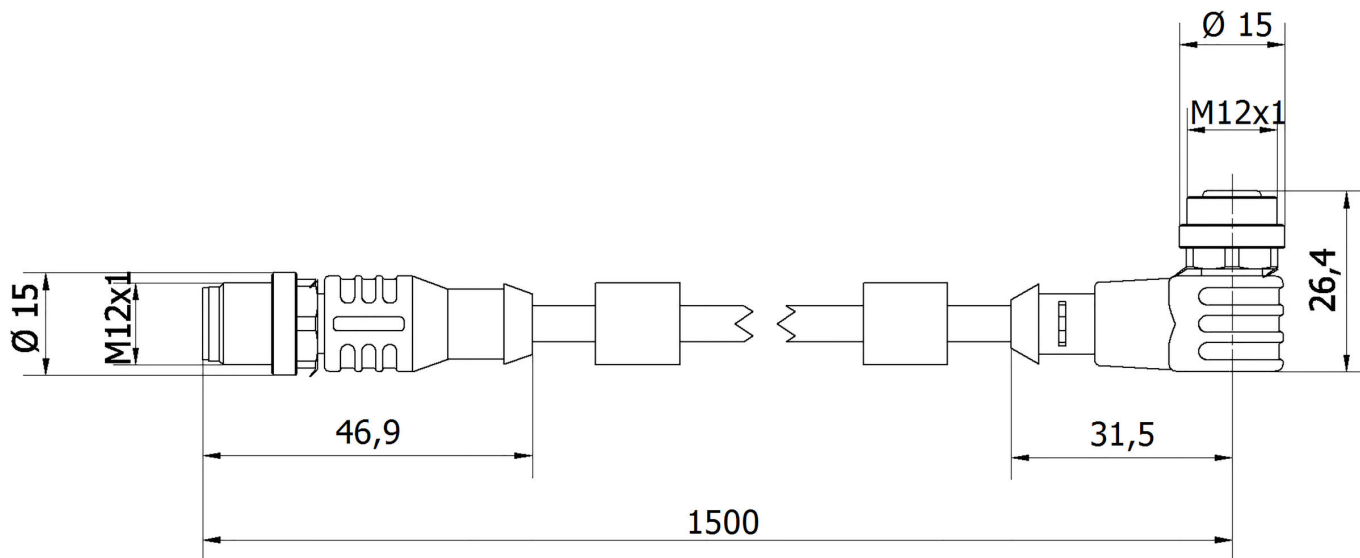

Extract accessories program

VK200021

 Connection cable, 2m, M12 Female (socket) 3pin Angular, Free conductor end, 3x0.34mm², PUR (Polyurethane), Ø4.3mm, 250V, -30-90°C, IP67, Suitable for trailing chain and torsion resistant, Oil and cooling lubricants, Welding area, Silicone-free

VK200025

 Connection cable, 2m, M12 Female (socket) 3pin Straight, Free conductor end, 3x0.34mm², PUR (Polyurethane), Ø4.3mm, 250V, -30-90°C, IP67, Suitable for trailing chain and torsion resistant, Oil and cooling lubricants, Welding area, Silicone-free

AV98F001



AV98F002

 Tool, wrench insert for torque wrench, SW13

VK003021

 Cable socket, Angular, Suitable for self-assembly, Screw connection, Ø3-6.5mm, 4A, 60V, -25-90°C, M12 Female (socket) 5pin, IP67, PBT

VK003025

 Cable socket, Straight, Suitable for self-assembly, Screw connection, Ø3-6.5mm, 4A, 60V, -25-90°C, M12 Female (socket) 5pin, IP67, PBT

VK003020

 Cable socket, angular, self-assembly, screw connection, Ø3-6.5mm, 4A, 240V, -25-90°C, M12 socket 4-pin, IP67, PBT

VK003024

 Cable socket, Straight, Suitable for self-assembly, Screw connection, Ø3-6.5mm, 4A, 240V, -25-90°C, M12 Female (socket) 4pin, IP67, PBT

AV000117

 Labeling material, Label, 2, 1x30x4mm, Plastic PC, 34 identification labels

You can find further accessories on our homepage



Installation

Mounting / installation may only be carried out by a qualified electrician!



Disposal

WEEE number according to § 6 para. 3 ElektroG: 40951076

Safety warnings

- / Before initial operation, please make sure to follow all safety instructions that may be provided in the product information.
- / Never use these devices in applications where the safety of a person depends on their functionality.