

## VK200F81

### Connection technology • Cable sockets / connectors pre-assembled on two sides

Connection cable, 2m, M8 socket 4-pin angular, M12 connector 4-pin straight, 4x0.34mm<sup>2</sup>, PUR (polyurethane), 60V, IP67, suitable for trailing chain and torsion resistant, oils and cooling lubricants, welding area, silicone-free



This connection cable has pre-wired connections on both sides. It can be used to cost-effectively integrate end devices with a plug connection via a distribution terminal or a logic module.

#### Electrical features

Type of plug-in contact, A connection	Female (socket)
Type of plug-in contact, B connection	Male (connector)
Type of A electrical connection	M8
Type of B electrical connection	M12
Number of pins of A connection	4
Number of pins of B connection	4
Operating voltage (AC 50Hz)	60 V
Operating voltage (DC)	60 V

#### Mechanical features

Number of cores	4
Wire assembly	42 x 0.1mm
Conductor cross-section	0.34 mm <sup>2</sup>
Cable length	2 m
Cable infeed of A connection	angular
Cable infeed of B connection	straight
Maximum tightening torque of connection A	0.6 Nm
Maximum tightening torque of connection B	1 Nm
bending cycles	5 million cycles
Degree of protection (IP)	IP67
Torsion cycles	+/-360°/m, ≥ 2 million cycles
Material of cable sheath	Plastic (PUR)
Perm. ambient temperature of cable, fixed cable	-25 - 80 °C
Suitable for trailing chain	Yes
Material of the screw fitting	Brass

**Other features**

Flame retardant	in accordance with EN 60332-2-2
Halogen-free	Yes
Hydrolysis-proof	Yes
Free of LABS	Yes
Ozone and UV-resistant	Yes
Suitable for trailing chain and torsion resistant	Yes
Welding area	Yes
Silicone-free	Yes
Oil and cooling lubricants	Yes

**Classification**

ETIM 8	EC001855 Assembled sensor-actuator cable
--------	--

**More**

IPF Product Group	851 cable sockets / connectors (both side ready made)
packaging dimensions	170 x 170 x 15 mm
gross weight	80 g
Customs tariff number	85444290
WEEE number	40951076
OzDS-compliant	Yes
POP-compliant	Yes
Reach-compliant	Yes
RoHS-compliant	Yes

**Connection**

**connector**

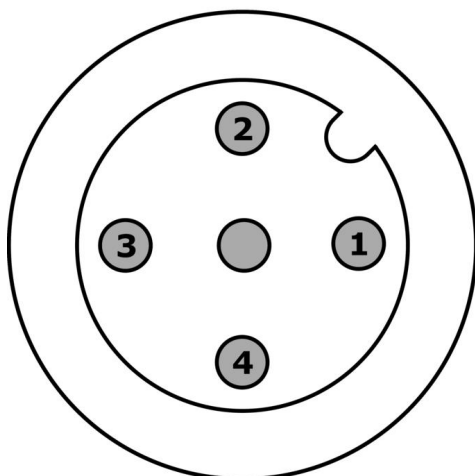

- 1** brown
- 2** white
- 3** blue
- 4** black

**socket**

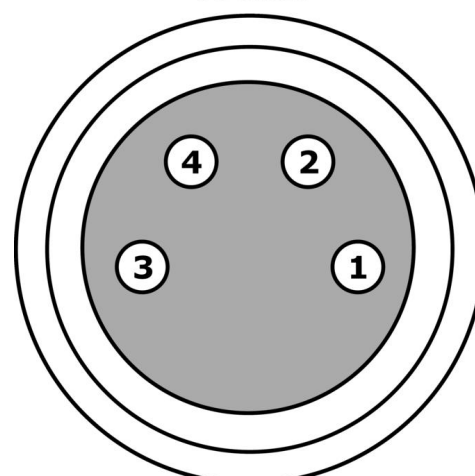

- 1** brown
- 2** white
- 3** blue
- 4** black

**Dimensional drawing**

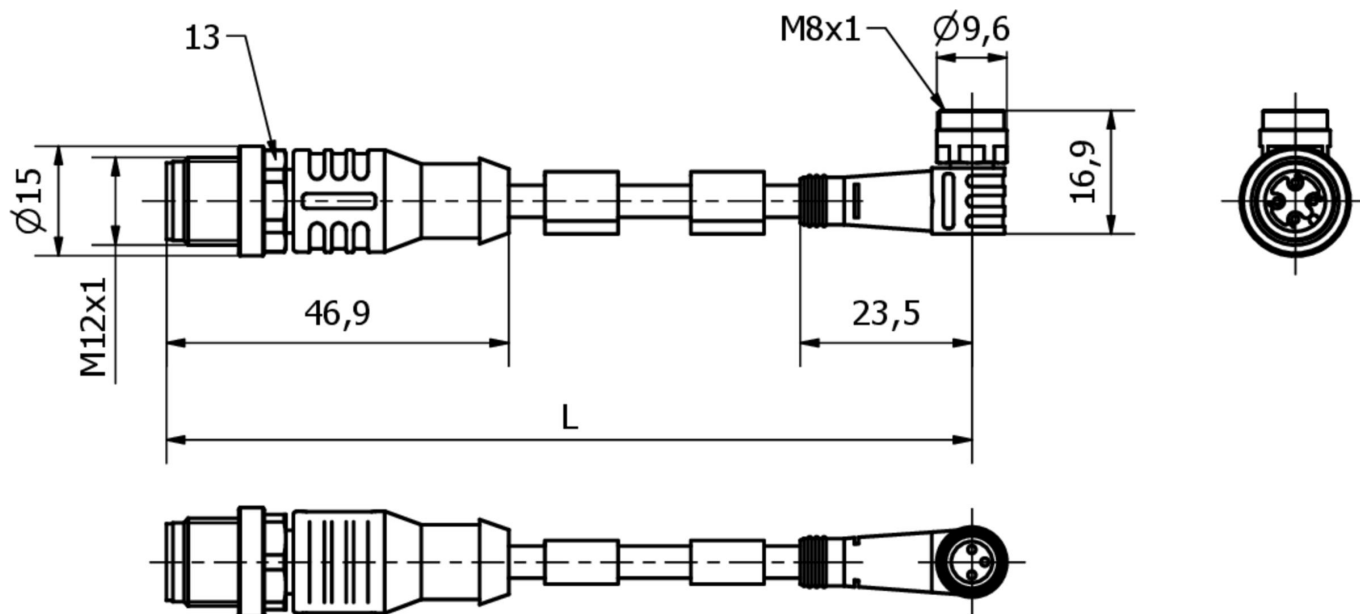

**Extract accessories program**

**VK200021**

 Connection cable, 2m, M12  
Female (socket) 3pin Angular, Free conductor end, 3x0.34mm<sup>2</sup>, PUR (Polyurethane), Ø4.3mm, 250V, -30-90°C, IP67, Suitable for trailing chain and torsion resistant, Oil and cooling lubricants, Welding area, Silicone-free

**VK200025**

 Connection cable, 2m, M12  
Female (socket) 3pin Straight, Free conductor end, 3x0.34mm<sup>2</sup>, PUR (Polyurethane), Ø4.3mm, 250V, -30-90°C, IP67, Suitable for trailing chain and torsion resistant, Oil and cooling lubricants, Welding area, Silicone-free

**AV98F001**



**AV98F002**

 Tool, wrench insert for torque wrench, SW13

**AY000141**

 Plastic sheath, Ø17mm, Inner diameter 10mm, -40-250°C, Glass fiber with silicone rubber, Short-term resistance to weld spatter 1200°C, Tensile strength 400N, Flexible, Flame retardant, yard good

**AV000117**

 Labeling material, Label, 2, 1x30x4mm, Plastic PC, 34 identification labels

**VK000037**

 Adaption, M12 Female (socket) 3pin Straight, M8 Male (connector) 3pin Straight, 24V, -25-85°C, IP67, Oil and cooling lubricants, Welding area

**VK003020**

 Cable socket, angular, self-assembly, screw connection, Ø3-6.5mm, 4A, 240V, -25-90°C, M12 socket 4-pin, IP67, PBT

**VK003024**

 Cable socket, Straight, Suitable for self-assembly, Screw connection, Ø3-6.5mm, 4A, 240V, -25-90°C, M12 Female (socket) 4pin, IP67, PBT

You can find further accessories on our homepage



**Installation**

Mounting / installation may only be carried out by a qualified electrician!



**Disposal**

WEEE number according to § 6 para. 3 ElektroG: 40951076

---

**Safety warnings**

- / Before initial operation, please make sure to follow all safety instructions that may be provided in the product information.
- / Never use these devices in applications where the safety of a person depends on their functionality.