

## VKB00071

### Connection technology • Cable sockets / connectors pre-assembled on one side

Connection cable, 20m, M8 socket 3-pin angular, free cable end, 3x0.34mm<sup>2</sup>, PUR (polyurethane), suitable for trailing chain and torsion resistant, oils and cooling lubricants, welding area, silicone-free



ipf cable sockets are mainly used for the electrical connection of sensors. Their properties are characterized by the robust version, in the highest degrees of protection (IP67 | IP68 | IP69K) and with 360° shielding on request. With the features: bus-compatible, drag chain and robot-compatible, oil and chemical-resistant, welding spark-resistant, cleaning agent-resistant or resistant to high-pressure and steam jet cleaning, the enlarged temperature range up to +230°C, rapid interconnection (technology) or special data transmission properties, the cable sockets meet all the requirements of automation technology.

#### Electrical features

Type of plug-in contact, A connection	Female (socket)
Type of A electrical connection	M8
Type of B electrical connection	Free conductor end
Number of pins of A connection	3
Operating voltage (AC 50Hz)	60 V
Operating voltage (DC)	60 V
Coding of connection A	A

#### Mechanical features

Number of cores	3
Conductor cross-section	0.34 mm <sup>2</sup>
Cable length	20 m
Cable infeed of A connection	angular
Maximum tightening torque of connection A	0.6 Nm
bending cycles	5 million cycles
Torsion cycles	+/-360°/m, ≥ 2 million cycles
Material of cable sheath	Kunststoff (PUR)
Material of the screw fitting	Brass
Line diameter	4.4 mm
ardTEME_Werkstoffeigenschaften	Halogenfrei   Hydrolysefest   LABS-frei   Ozonbeständig   Silikonfrei   UV-Beständig
ardTEME_Umgebungsbestaendigkeiten	Öle   Kühlschmiermittel

#### Other features

Flame retardant	in accordance with EN 60332-2-2
ardTE00_Anwendungen	Schleppkettentauglich   Schweißbereich

**Classification**

ETIM 8	EC001855 Assembled sensor-actuator cable
--------	--

**More**

IPF Product Group	850 cable sockets / connectors (one side ready made)
packaging dimensions	190 x 190 x 35 mm
gross weight	482 g
Customs tariff number	85444290
WEEE number	40951076
OzDS-compliant	Yes
POP-compliant	Yes
Reach-compliant	Yes
RoHS-compliant	Yes

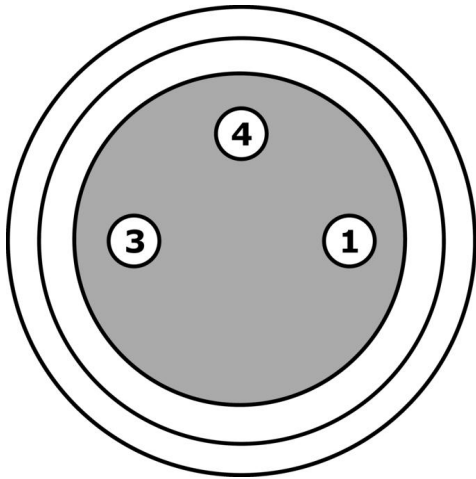
**Connection****1** brown**3** blue**4** black

Dimensional drawing

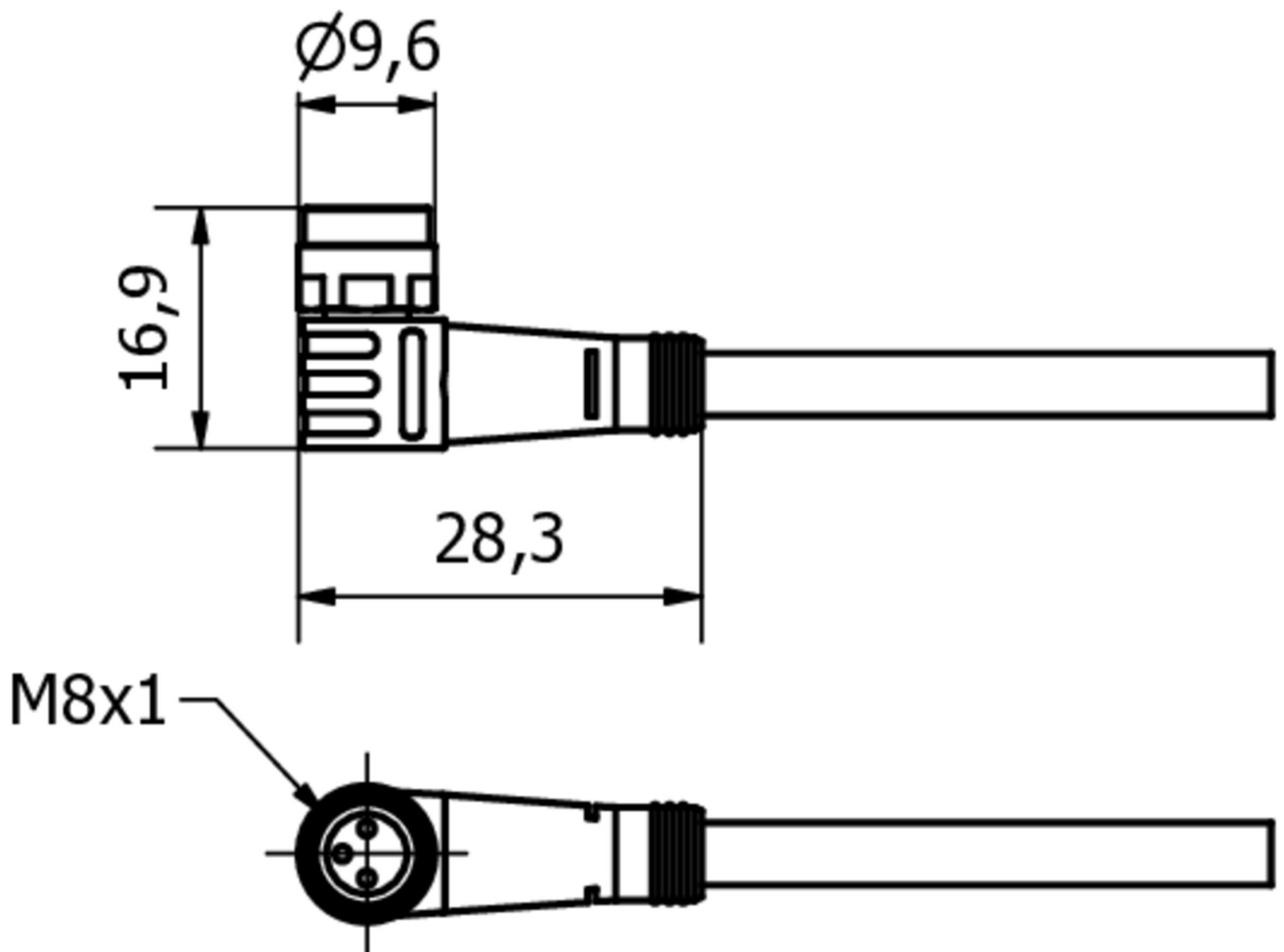

**Extract accessories program**

**AV000130**

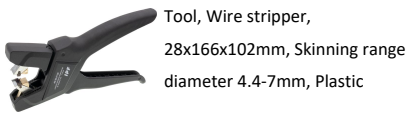

**AV000132**

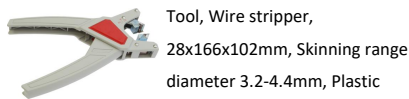

**AV98F001**



**AV98F002**

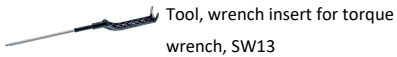

**AY000141**

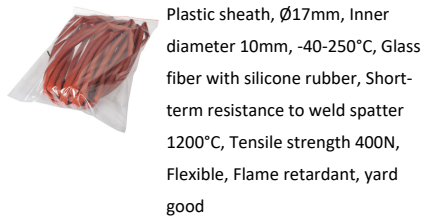

**AV000116**

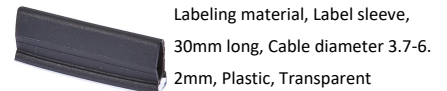

**AV000140**



You can find further accessories on our homepage



**Installation**

Mounting / installation may only be carried out by a qualified electrician!



**Disposal**

WEEE number according to § 6 para. 3  
ElektroG: 40951076

**Safety warnings**

/ Before initial operation, please make sure to follow all safety instructions that may be provided in the product information.

/ Never use these devices in applications where the safety of a person depends on their functionality.