

dimensions	<b>G½"</b> <b>G1"</b> <b>G1½"</b>	
level detection	probe length	<b>500mm</b> <b>1000mm</b> <b>1600mm</b>

- ✓ process pressures up to 20bar
- ✓ process temperature up to +150°C



**up to four limit levels per probe  
probes can be shortened to any length**

**description**

The electrode probes from *ipf electronic* are used in combination with the corresponding filling level relays for conductive limit level detection in electrically conductive filling materials. The electrode rods are fastened to a process connection, whereby the rods may have a length of up to 1600mm. To differentiate between different filling levels, the electrode rods can be shortened to the desired length.

With up to five contact electrodes, multiple tasks can be fulfilled simultaneously. These include, e.g., leakage and overflow protection, minimum/maximum protection or multiple point detection in containers, pump protection or dry-run protection in pipes or the two-step control of pumps.

The electrode probes are designed for a wide range of applications. Conductivities above 1 µS/cm can be detected at process temperatures from -15°C to +110°C and pressures from -1bar to +10bar.

The probe is installed either directly above the respective process connection in the container wall or pipe

wall or by means of a suitable holder above the filling material. The AC voltage generated by the **FV56** filling level relay is applied either between the electrode rods or between the electrode rods and the metallic container wall or pipe wall connected with the filling level relay.

As soon as the electrically conductive filling material establishes a connection between the electrodes or between the electrodes and the metallic container wall or pipe wall, a measurable current flows that brings about a reaction of the connected filling level relay. The use of an AC voltage prevents corrosion at the electrode and the electrolytic decomposition of the filling material.

**application examples**

- ▶ leakage and overflow protection
- ▶ dry-run protection for pumps
- ▶ two-step control in systems
- ▶ limit level monitoring in containers

article-no.

FS906000

FS906001

connection sensing element

G $\frac{1}{2}$ "

G $\frac{1}{2}$ "

version

1 probe, L1: 500mm,  $\varnothing$  4mm

1 probe, L1: 1000mm,  $\varnothing$  4mm

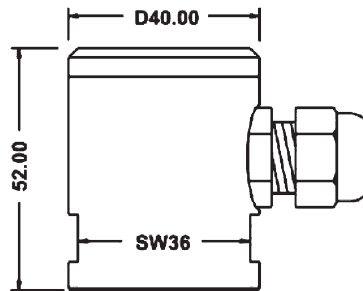

connection housing  
 $\varnothing$  40mm

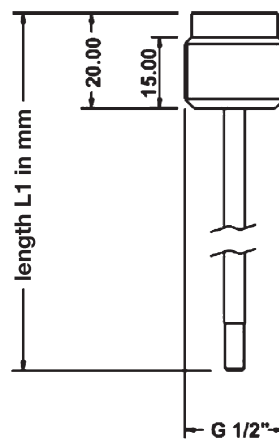

### TECHNICAL DATA

	FS906000	FS906001
connection sensing element	G $\frac{1}{2}$ "	G $\frac{1}{2}$ "
version	1 probe, L1: 500mm, $\varnothing$ 4mm	1 probe, L1: 1000mm, $\varnothing$ 4mm
housing material	POM-polyoxymethylene	POM-polyoxymethylene
sensing element material	stainless steel 1.4404 insulation: PA-polyamide	stainless steel 1.4404 insulation: PA-polyamide
operating temperature	-15 ... +150°C	-15 ... +150°C
pressure resistance	-1 ... +10bar	-1 ... +10bar
degree of protection (EN60529)	IP65	IP65
connection	terminals	terminals

article-no.	FS926030	FS92A789
connection sensing element	G1"	G1"
version	3 probes, L1: 1000mm, Ø 4mm	4 probes, L1: 1000mm, Ø 4mm

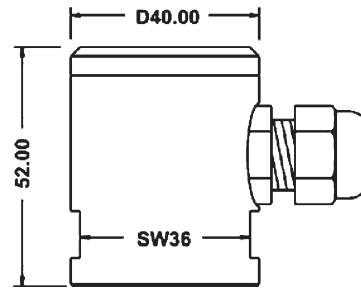

connection housing  
Ø 40mm

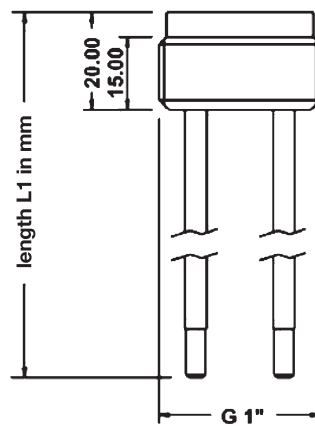

**TECHNICAL DATA**

connection sensing element	G1"	G1"
version	3 probes, L1: 1000mm, Ø 4mm	4 probes, L1: 1000mm, Ø 4mm
housing material	POM-polyoxymethylene	POM-polyoxymethylene
sensing element material	stainless steel 1.4404 insulation: PA-polyamide	stainless steel 1.4404 insulation: PA-polyamide
operating temperature	-15 ... +150°C	-15 ... +150°C
operating pressure resistance	-1 ... +10bar	-1 ... +10bar
degree of protection (EN60529)	IP65	IP65
connection	terminals	terminals

article-no.

FS94A946

FS94C375

connection sensing element

G1½"

G1½"

version

5 probes, L1: 1000mm, Ø 4mm

4 probes, L1: 1600mm, Ø 4mm

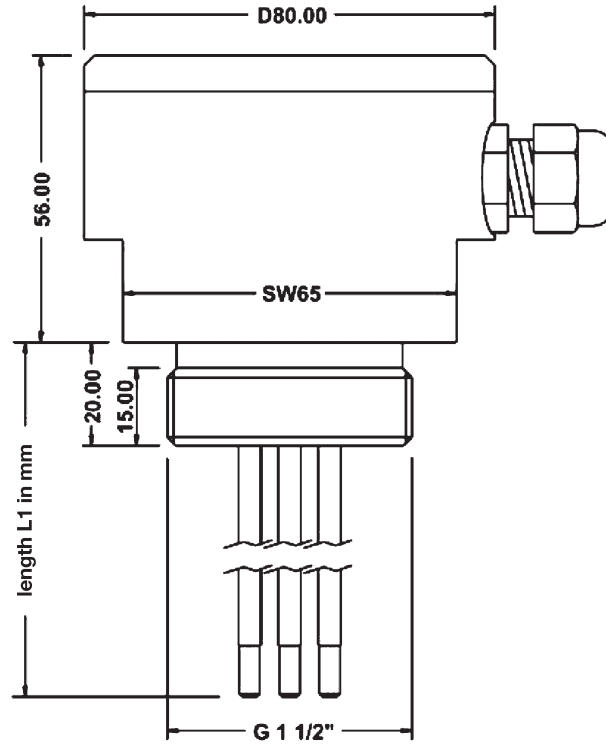

### TECHNICAL DATA

	FS94A946	FS94C375
connection sensing element	G1½"	G1½"
version	5 probes, L1: 1000mm, Ø 4mm	4 probes, L1: 1600mm, Ø 4mm
housing material	POM-polyoxymethylene	POM-polyoxymethylene
sensing element material	stainless steel 1.4404 insulation: PA-polyamide	stainless steel 1.4404 insulation: PA-polyamide
operating temperature	-15 ... +150°C	-15 ... +150°C
pressure resistance	-1 ... +10bar	-1 ... +10bar
degree of protection (EN60529)	IP65	IP65
connection	terminals	terminals

article-no.  
connection sensing element  
version

FS946031  
G1½"  
3 probes, L1: 1000mm, Ø 4mm

10

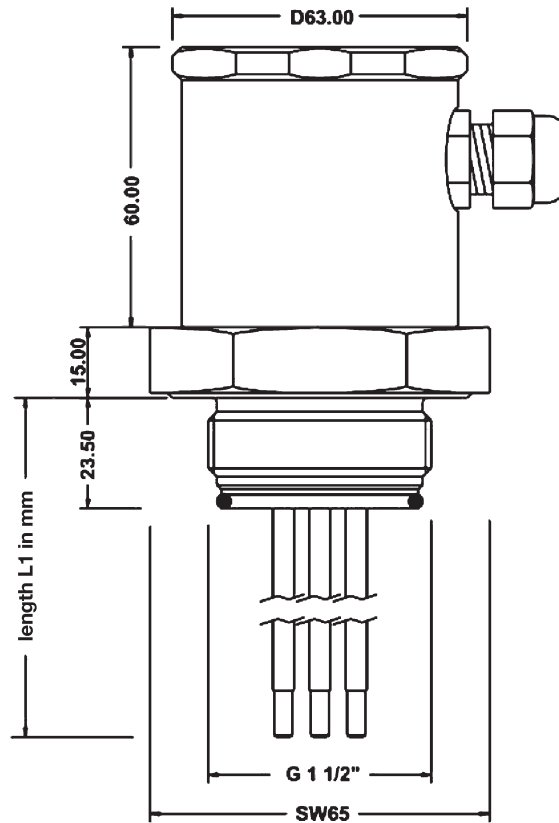

**TECHNICAL DATA**

connection sensing element	G1½"
version	3 probes, L1: 1000mm, Ø 4mm
housing material	POM-polyoxymethylene
sensing element material	stainless steel 1.4404 insulation: E-CTFE (Halar)
operating temperature	-15 ... +150°C
pressure resistance	-1 ... +20bar
degree of protection (EN60529)	IP65
connection	terminals

### Mounting instruction

Before mounting or removing the device, the system must be depressurized. High temperatures should also be avoided in order to prevent injuries. Ensure that there is sufficient free space for mounting outside of the container so that the electrode probe can be inserted into the system without the use of force.

If necessary, mount the device in a bypass if heavy foam, wild turbulence or foamed liquid is to be expected.

Mount the electrode probe at a location in the container where no strong lateral forces, such as near stirrers or filling openings, can act on the electrode rods. This applies, in particular, for especially long electrode rods.

Once installed, the uninsulated electrode tips must not come into contact with the container wall if the wall is made of metal or electrically conductive plastic.

For electrode rods longer than 0.5m, the rods are to be stabilized with respect to both one another as well as the container wall, especially if the filling material is a heavily agitated filling material. For this purpose, use suitable insulating spacers. The distance between the spacers should not exceed 0.5m.

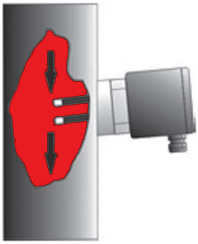

At installation in a container or in a pipe, the electrode rod length should not exceed 200mm for reasons of stability. In addition, the electrode rods should be mounted with the electrode tips oriented slightly downward (approx. 20°) so that liquid residues to run off more easily and thereby also avoid the formation of deposits.



The length of the electrodes must be selected such that with an empty pipe, the electrically conductive filling between electrodes and wall or between the two electrodes can break even in the presence of liquid residues, as this can otherwise be interpreted as being full even if empty.

For process connections with a screw-in thread, the tightening of the process connection must only be performed at the hexagon nut with an appropriate wrench. The maximum permissible tightening torque is 100Nm. It is not permissible to screw in the process connection using the connection housing.

### connection

For the connection, use only suitable cables with max. 25Ω per wire that meet the requirements regarding, e.g., temperature, material or laying at the installation site.

The cable gland is suitable for cable diameters from 3.5 to 8mm. After installing the cable, the cable gland is to be securely tightened to ensure the impermeability of the connection housing.

If possible, shielded signal and measurement lines that are spatially separated from power-carrying lines should be laid. If strong electromagnetic interference is present, always use a shielded cable. Ground the cable shielding at one end of the cable.

A suitable evaluation device of type **FV56** is to be connected with the electrode rods in the interior of the connection housing via the connection cable. The cable is connected to the electrode rods via terminals for a wire cross section of up to 2.5 mm<sup>2</sup> or via screw connections in the connection housing. Use insulated cable lugs for the connection.

For devices with metallic process connection, contact can be established via a blade terminal.

This data sheet only contains the available standard variants. For other output / connection variants, we kindly ask that you contact us.

We are happy to supply the right cable socket for the plug equipment. You will find a list in the “accessories” section of the catalog under **ipf-SENSORFLEX**® “cable sockets” or in the search window on our homepage [www.ipf-electronic.com](http://www.ipf-electronic.com) (using the search term “VK”).

**Warning:** Never use these devices in applications where the safety of a person depends on their functionality.

You also find this data sheet, as well as contact details under [www.ipf-electronic.com](http://www.ipf-electronic.com)