

- ▶ norm design
- ▶ teach-in
- ▶ high-power
- ▶ analog
- ▶ differential evaluation
- ▶ laser

forked light barriers

NOTES

A large grid area for taking notes, consisting of a 20x30 grid of small squares. The grid is empty and occupies the majority of the page below the 'NOTES' header.

dimensions **41 x 25 x 12mm**
to
140 x 274 x 12mm

through-beam fork width **2mm**
to
250mm

- ✓ **robust metal housing**
- ✓ **easy mounting and high degree of protection**
- ✓ **LED-display**
- ✓ **adjustable sensitivity**
- ✓ **integrated amplifier**
- ✓ **high switching frequency**

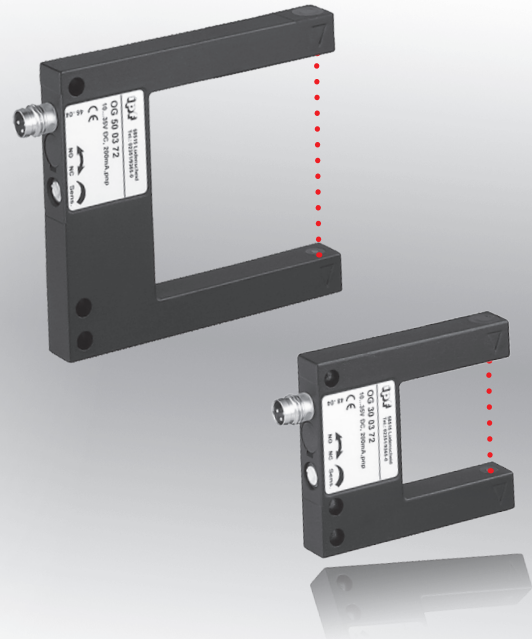

norm design
infrared or red light

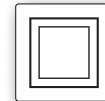

description

The transmitter and the receiver, as well as the whole electronics, are all in just one housing (integrated photoelectric sensors), this guarantees very quick and easy mounting. Optoelectronic forked light barriers operate either with constant (infrared light non-pulsed) or with an alternating light that is strongly shielded against external light sources (pulsed infrared or visible red light). The devices with visible red light are fitted with a scratch resistant collimating lens made from mineral glass. The integrated amplifier transforms any interruption of the light beam into a switch signal. The sensitivity can be adjusted using the integrated potentiometer.

The forked light barriers are thereby also able to recognize print marks or labels on translucent backing material. High resolution and short response time guarantee accurate positioning and reliable detection of extremely fast motions.

application examples

- ▶ part detection in feed rails
- ▶ quality assurance in automated production processes
- ▶ position switches, pulse generators or limit value sensors in automatic machinery and production processes
- ▶ triggering of counters, rotation speed monitors, linear or angle measurement

article-no.	OG020370	OG032100	OG032180
transmitting element (non-pulsed)	infrared	infrared	infrared
fork width	2mm	3mm	3mm
output	npn, no / nc	npn, no	npn, no

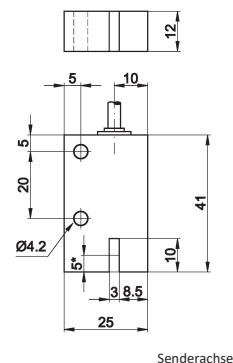
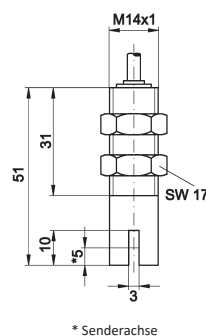
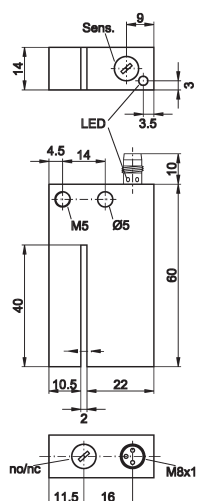

TECHNICAL DATA

fork width	2mm	3mm	3mm
resolution *	Ø 0.4mm	Ø 0.8mm	Ø 0.8mm
output	npn, no / nc	npn, no	npn, no
operating voltage	10 ... 35V DC	4.5 ... 30V DC	4.5 ... 30V DC
current consumption (w/o load)	< 30mA	< 25mA	< 25mA
output current (max. load)	200mA	100mA	100mA
voltage drop (max. load)	2.8V DC	1V DC	1V DC
hysteresis	0.1mm	0.1mm	0.1mm
repeat accuracy	0.05mm	0.01mm	0.01mm
transmitting element (non-pulsed)	infrared	infrared	infrared
wavelength	880nm	935nm	935nm
switching frequency	10kHz	50kHz	50kHz
display (signal)		yellow LED	- -
sensitivity adjustment	potentiometer	-	-
short-circuit protection	+	-	-
reverse polarity protection	+	+	+
housing material	zinc	brass	brass
dimensions	60x34.5x14mm	M14x51mm	41x25x12mm
operating temperature	-10 ... +60°C	-25 ... +65°C	-25 ... +65°C
degree of protection (EN 60529)	IP67	IP65	IP65
connection	M8-connector, 3-pin	cable, 2m, 3-wire	cable, 2m, 3-wire
connection accessories	e.g. VK200075	-	-

* smallest detectable object

article-no.	OG050171	OG100371
transmitting element (pulsed)	infrared	infrared
fork width	5mm	10mm
output	npn, no	npn, no / nc
TECHNICAL DATA		
fork width	5mm	10mm
resolution *	Ø 0.5mm	Ø 0.3mm
output	npn, no	npn, no / nc
operating voltage	10 ... 35V DC	10 ... 35V DC
current consumption (w/o load)	< 35mA	< 30mA
output current (max. load)	200mA	200mA
voltage drop (max. load)	2.5V DC	1.5V DC
hysteresis	0.2mm	0.1mm
repeat accuracy	0.01mm	0.1mm
transmitting element (non-pulsed)	-	-
transmitting element (pulsed)	infrared	infrared
wavelength	880nm	880nm
switching frequency	1kHz	1kHz
display (signal)	yellow LED	yellow LED
sensitivity adjustment	potentiometer	potentiometer
short-circuit protection	+	+
reverse polarity protection	+	+
housing material	aluminum	zinc diecast
dimensions	45x25x10mm	45x25x10mm
operating temperature	-10 ... +60°C	-10 ... +60°C
degree of protection (EN 60529)	IP67	IP67
connection	M8-connector, 3-pin	M8-connector, 3-pin
connection accessories	e.g. VK200075	e.g. VK200075
* smallest detectable object		

article-no.	OG200371	OG300371	OG400371
transmitting element (pulsed)	infrared	infrared	infrared
fork width	20mm	30mm	40mm
output	npn, no / nc	npn, no / nc	npn, no / nc
article-no.	OG200372	OG300372	OG400372
transmitting element (pulsed)	red light	red light	red light
fork width	20mm	30mm	40mm
output	npn, no / nc	npn, no / nc	npn, no / nc

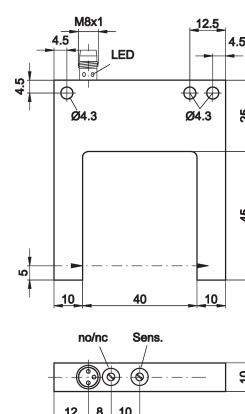
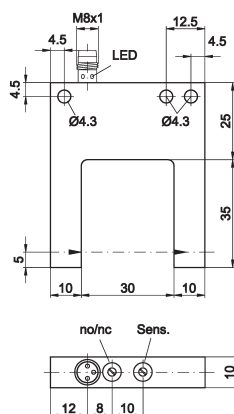
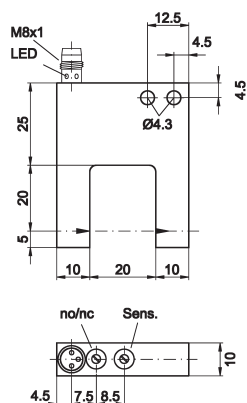

TECHNICAL DATA

fork width	20mm	30mm	40mm
resolution *	Ø 0.4mm	Ø 0.5mm	Ø 0.5mm
output	npn, no / nc	npn, no / nc	npn, no / nc
operating voltage	10 ... 35V DC	10 ... 35V DC	10 ... 35V DC
current consumption (w/o load)	< 30mA	< 30mA	< 30mA
output current (max. load)	200mA	200mA	200mA
voltage drop (max. load)	2.8V DC	2.8V DC	2.8V DC
hysteresis	0.1mm	0.25mm	0.25mm
repeat accuracy	0.02mm	0.02mm	0.04mm
transmitting element (pulsed)	infrared / red light	infrared / red light	infrared / red light
wavelength	880nm / 660nm	880nm / 660nm	880nm / 660nm
switching frequency	4kHz	4kHz	4kHz
display (signal)	yellow LED	yellow LED	yellow LED
sensitivity adjustment	potentiometer	potentiometer	potentiometer
short-circuit protection	+	+	+
reverse polarity protection	+	+	+
housing material	zinc diecast	zinc diecast	zinc diecast
dimensions	50x40x10mm	60x50x10mm	70x60x10mm
operating temperature	-10 ... +60°C	-10 ... +60°C	-10 ... +60°C
degree of protection (EN 60529)	IP67	IP67	IP67
connection	M8-connector, 3-pin	M8-connector, 3-pin	M8-connector, 3-pin
connection accessories	e.g. VK200075	e.g. VK200075	e.g. VK200075

* smallest detectable object

article-no.	OG500371	OG600371	OG700371
transmitting element (pulsed)	infrared	infrared	infrared
fork width	50mm	60mm	70mm
output	pnp, no / nc	pnp, no / nc	pnp, no / nc
article-no.	OG500372	OG600372	OG700372
transmitting element (pulsed)	red light	red light	red light
fork width	50mm	60mm	70mm
output	pnp, no / nc	pnp, no / nc	pnp, no / nc

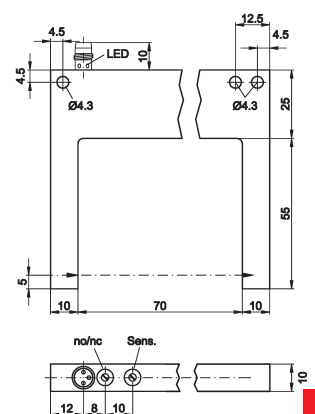
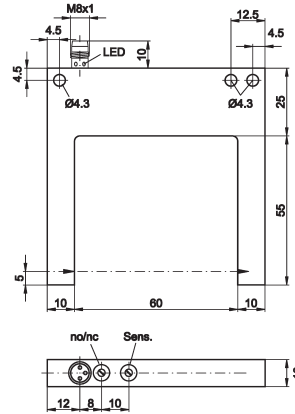
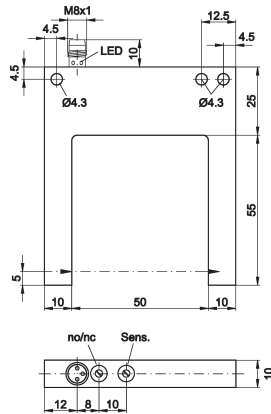

TECHNICAL DATA

fork width	50mm	60mm	70mm
resolution *	Ø 0.5mm	Ø 0.5mm	Ø 0.5mm
output	pnp, no / nc	pnp, no / nc	pnp, no / nc
operating voltage	10 ... 35V DC	10 ... 35V DC	10 ... 35V DC
current consumption (w/o load)	< 30mA	< 30mA	< 30mA
output current (max. load)	200mA	200mA	200mA
voltage drop (max. load)	2.8V DC	2.8V DC	2.8V DC
hysteresis	0.25mm	0.25mm	0.25mm
repeat accuracy	0.04mm	0.06mm	0.06mm
transmitting element (pulsed)	infrared / red light	infrared / red light	infrared / red light
wavelength	880nm / 660nm	880nm / 660nm	880nm / 660nm
switching frequency	4kHz	4kHz	4kHz
display (signal)	yellow LED	yellow LED	yellow LED
sensitivity adjustment	potentiometer	potentiometer	potentiometer
short-circuit protection	+	+	+
reverse polarity protection	+	+	+
housing material	zinc diecast	aluminum	aluminum
dimensions	80x70x10mm	80x80x10mm	80x90x10mm
operating temperature	-10 ... +60°C	-10 ... +60°C	-10 ... +60°C
degree of protection (EN 60529)	IP67	IP67	IP67
connection	M8-connector, 3-pin	M8-connector, 3-pin	M8-connector, 3-pin
connection accessories	e.g. VK200075	e.g. VK200075	e.g. VK200075

* smallest detectable object

article-no.	OG800371	OG900371	OGK00371
transmitting element (pulsed)	infrared	infrared	infrared
fork width	80mm	90mm	100mm
output	npn, no / nc	npn, no / nc	npn, no / nc
article-no.	OG800372	OG900372	OGK00372
transmitting element (pulsed)	red light	red light	red light
fork width	80mm	90mm	100mm
output	npn, no / nc	npn, no / nc	npn, no / nc

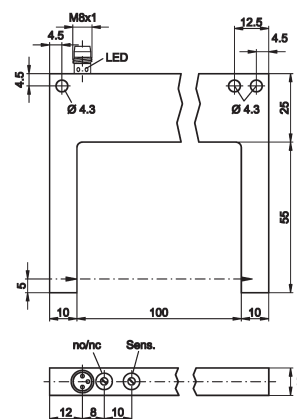
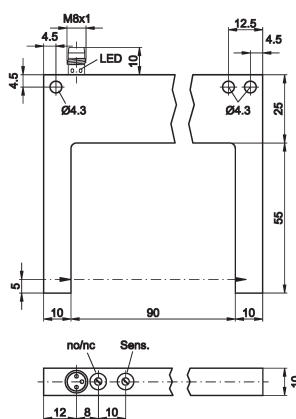
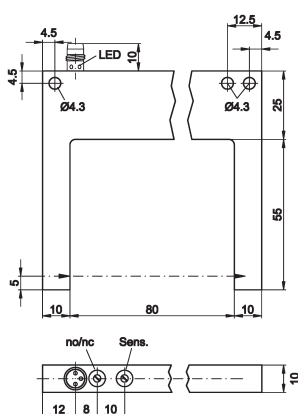

TECHNICAL DATA

fork width	80mm	90mm	100mm
resolution *	Ø 0.5mm	Ø 0.5mm	Ø 0.7mm
output	npn, no / nc	npn, no / nc	npn, no / nc
operating voltage	10 ... 35V DC	10 ... 35V DC	10 ... 35V DC
current consumption (w/o load)	< 30mA	< 30mA	< 30mA
output current (max. load)	200mA	200mA	200mA
voltage drop (max. load)	2.8V DC	2.8V DC	2.8V DC
hysteresis	0.25mm	0.25mm	0.25mm
repeat accuracy	0.06mm	0.06mm	0.06mm
transmitting element (pulsed)	infrared / red light	infrared / red light	infrared / red light
wavelength	880nm / 660nm	880nm / 660nm	880nm / 660nm
switching frequency	4kHz	4kHz	4kHz
display (signal)	yellow LED	yellow LED	yellow LED
sensitivity adjustment	potentiometer	potentiometer	potentiometer
short-circuit protection	+	+	+
reverse polarity protection	+	+	+
housing material	zinc diecast	aluminum	zinc diecast
dimensions	80x100x10mm	80x110x10mm	80x120x10mm
operating temperature	-10 ... +60°C	-10 ... +60°C	-10 ... +60°C
degree of protection (EN 60529)	IP67	IP67	IP67
connection	M8-connector, 3-pin	M8-connector, 3-pin	M8-connector, 3-pin
connection accessories	e.g. VK200075	e.g. VK200075	e.g. VK200075

* smallest detectable object

article-no.	OGKB0371	OGKE0371
transmitting element (pulsed)	infrared	infrared
fork width	120mm	150mm
output	npn, no / nc	npn, no / nc
article-no.	OGKB0372	-
transmitting element (pulsed)	red light	-
fork width	120mm	-
output	npn, no / nc	-

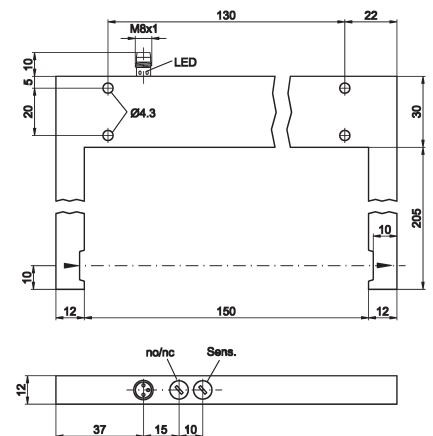
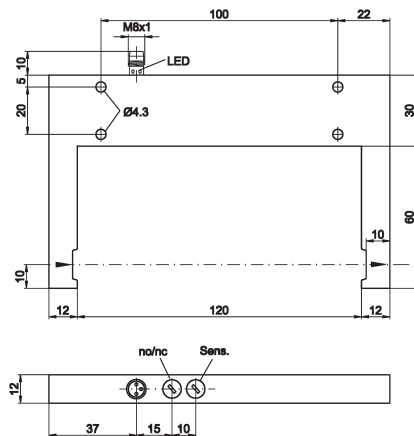

TECHNICAL DATA

fork width	120mm	150mm
resolution *	Ø 0.8mm	Ø 0.8mm
output	npn, no / nc	npn, no / nc
operating voltage	10 ... 35V DC	10 ... 35V DC
current consumption (w/o load)	< 45mA	< 45mA
output current (max. load)	200mA	200mA
voltage drop (max. load)	2.8V DC	2.8V DC
hysteresis	0.2mm / 0.25mm	0.2mm
repeat accuracy	0.06mm	0.06mm
transmitting element (pulsed)	infrared / red light	infrared
wavelength	880nm / 660nm	880nm
switching frequency	2kHz	2kHz
display (signal)	yellow LED	yellow LED
sensitivity adjustment	potentiometer	potentiometer
short-circuit protection	+	+
reverse polarity protection	+	+
housing material	zinc diecast	aluminum
dimensions	90x144x12mm	235x174x12mm
operating temperature	-10 ... +60°C	-10 ... +60°C
degree of protection (EN 60529)	IP67	IP67
connection	M8-connector, 3-pin	M8-connector, 3-pin
connection accessories	e.g. VK200075	e.g. VK200075

* smallest detectable object

article-no.	OGKG0371	OGLB0371
transmitting element (pulsed)	infrared	infrared
fork width	170mm	220mm
output	pnp, no / nc	pnp, no / nc
article-no.	OGKG0372	OGLB0372
transmitting element (pulsed)	red light	red light
fork width	170mm	220mm
output	pnp, no / nc	pnp, no / nc

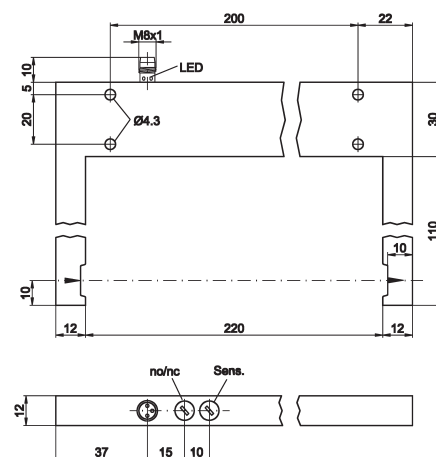
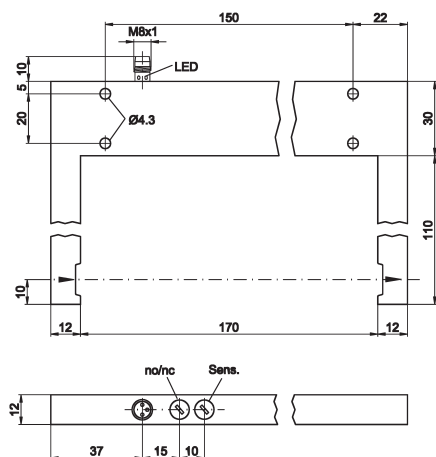

TECHNICAL DATA

fork width	170mm	220mm
resolution *	Ø 1.0mm	Ø 1.5mm
output	pnp, no / nc	pnp, no / nc
operating voltage	10 ... 35V DC	10 ... 35V DC
current consumption (w/o load)	< 40mA	< 40mA
output current (max. load)	200mA	200mA
voltage drop (max. load)	2.8V DC	2.8V DC
hysteresis	0.25mm	0.25mm
repeat accuracy	0.06mm	0.06mm
transmitting element (pulsed)	infrared / red light	infrared / red light
wavelength	880nm / 660nm	880nm / 660nm
switching frequency	2kHz	2kHz
display (signal)	yellow LED	yellow LED
sensitivity adjustment	potentiometer	potentiometer
short-circuit protection	+	+
reverse polarity protection	+	+
housing material	aluminum	aluminum
dimensions	140x194x12mm	140x244x12mm
operating temperature	-10 ... +60°C	-10 ... +60°C
degree of protection (EN 60529)	IP67	IP67
connection	M8-connector, 3-pin	M8-connector, 3-pin
connection accessories	e.g. VK200075	e.g. VK200075

* smallest detectable object

article-no.	OGLE0371
transmitting element (pulsed)	infrared
fork width	250mm
output	pnp, no / nc

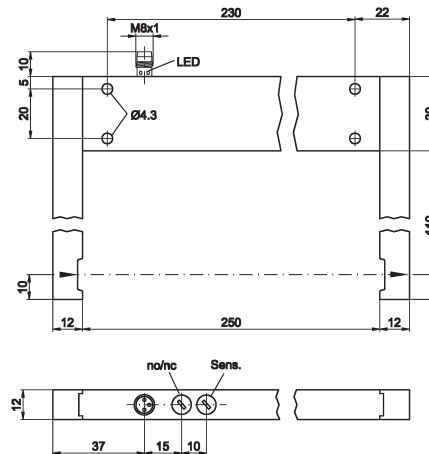

TECHNICAL DATA

fork width	250mm
resolution *	Ø 2.0mm
output	pnp, no / nc
operating voltage	10 ... 35V DC
current consumption (w/o load)	≤ 40mA
output current (max. load)	200mA
voltage drop (max. load)	2.8V DC
hysteresis	0.25mm
repeat accuracy	0.06mm
transmitting element (pulsed)	infrared
wavelength	880nm
switching frequency	2kHz
display (signal)	yellow LED
sensitivity adjustment	potentiometer
short-circuit protection	+
reverse polarity protection	+
housing material	aluminum
dimensions	140x274x12mm
operating temperature	-10 ... +60°C
degree of protection (EN 60529)	IP67
connection	M8-connector, 3-pin
connection accessories	e.g. VK200075

* smallest detectable object

NOTES

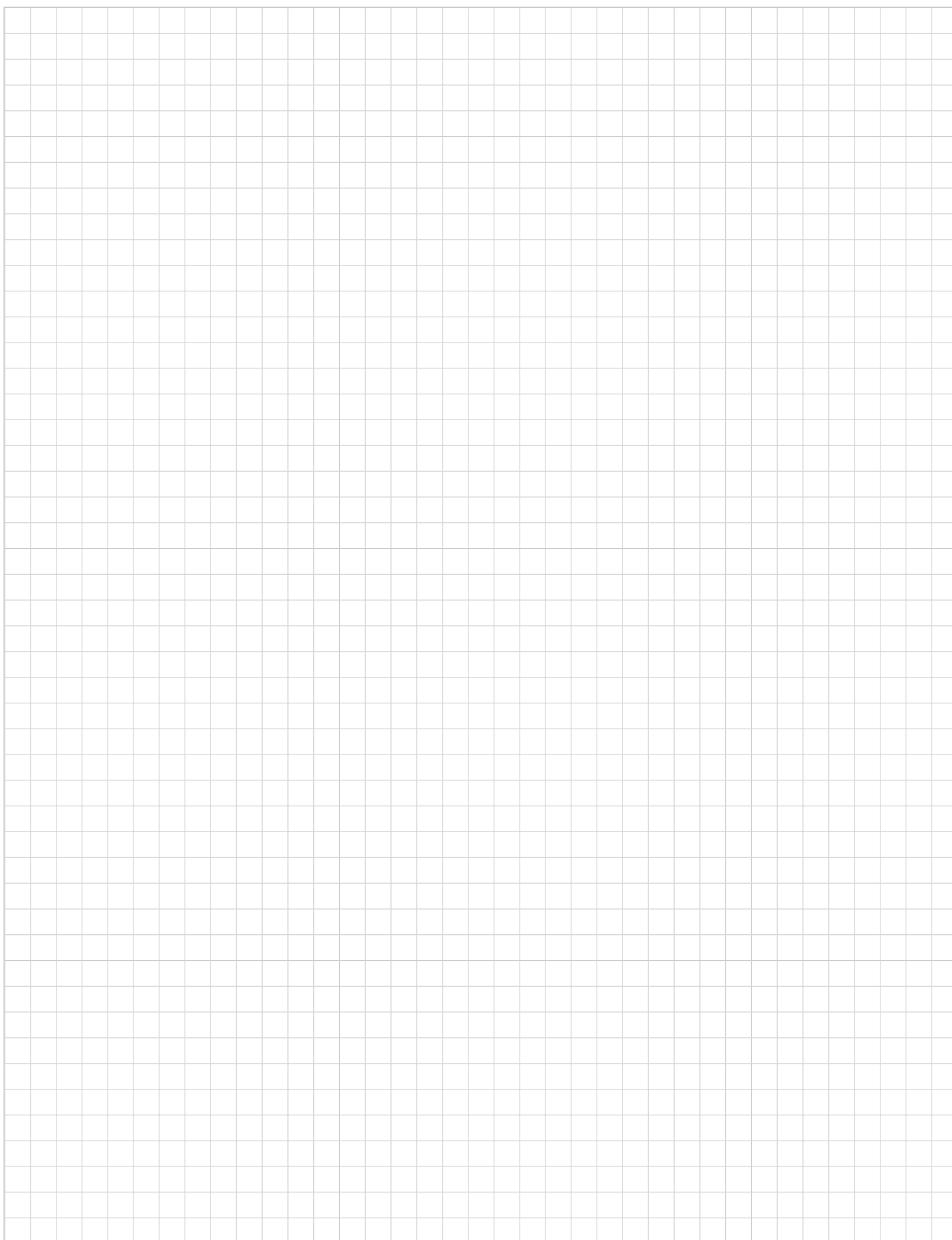

article-no.	OG020373	OG050373	OG300374
version	teach-button	teach-button	teach-button
transmitting element (pulsed)	infrared light	infrared light	red light
fork width	2mm	5mm	30mm

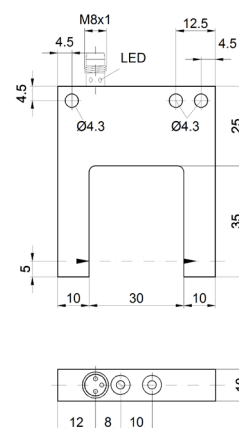
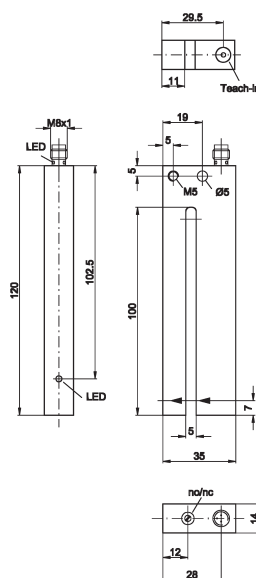
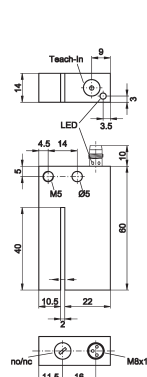

TECHNICAL DATA

fork width	2mm	2mm	30mm
resolution *	Ø 0.5mm	Ø 0.5mm	Ø 0.3mm
output	npn, no / nc	npn, no / nc	npn, no / nc
operating voltage	10 ... 35V DC	10 ... 35V DC	10 ... 35V DC
current consumption (w/o load)	< 35mA	< 35mA	< 30mA
output current (max. load)	200mA	200mA	200mA
voltage drop (max. load)	2.0V DC	2.0V DC	2.0V DC
hysteresis	0.1mm	0.1mm	0.1mm
repeat accuracy	0.03mm	0.03mm	0.03mm
transmitting element (pulsed)	infrared	infrared	red light
wavelength	880nm	880nm	660nm
switching frequency	3kHz	3kHz	2kHz
display (signal)	yellow LED	yellow LED	yellow LED
sensitivity adjustment	teach-button	teach-button remote-teach input	teach-button
short-circuit protection	+	+	+
reverse polarity protection	+	+	+
housing material	zinc diecast	zinc diecast	zinc diecast
dimensions	60x34.5x14mm	120x35x14mm	60x50x10mm
operating temperature	-10 ... +60°C	-10 ... +60°C	-10 ... +60°C
degree of protection (EN 60529)	IP67	IP67	IP67
connection	M8-connector, 3-pin	M8-connector, 4-pin	M8-connector, 3-pin
connection accessories	e.g. VK200075	e.g. VK200375	e.g. VK200075

* smallest detectable object

article-no.	OG500374	OG800374
version	teach-button	teach-button
transmitting element (pulsed)	red light	red light
fork width	50mm	80mm
TECHNICAL DATA		
fork width	50mm	80mm
resolution *	Ø 0.3mm	Ø 0.3mm
output	pnp, no / nc	pnp, no / nc
operating voltage	10 ... 35V DC	10 ... 35V DC
current consumption (w/o load)	< 30mA	< 30mA
output current (max. load)	200mA	200mA
voltage drop (max. load)	2.0V DC	2.0V DC
hysteresis	0.1mm	0.1mm
repeat accuracy	0.03mm	0.03mm
transmitting element (pulsed)	red light	red light
wavelength	660nm	660nm
switching frequency	3kHz	3kHz
display (signal)	yellow LED	yellow LED
sensitivity adjustment	teach-button	teach-button
short-circuit protection	+	+
reverse polarity protection	+	+
housing material	zinc diecast	zinc diecast
dimensions	80x70x10mm	80x100x10mm
operating temperature	-10 ... +60°C	-10 ... +60°C
degree of protection (EN 60529)	IP67	IP67
connection	M8-connector, 3-pin	M8-connector, 3-pin
connection accessories	e.g. VK200075	e.g. VK200075
* smallest detectable object		



NOTES

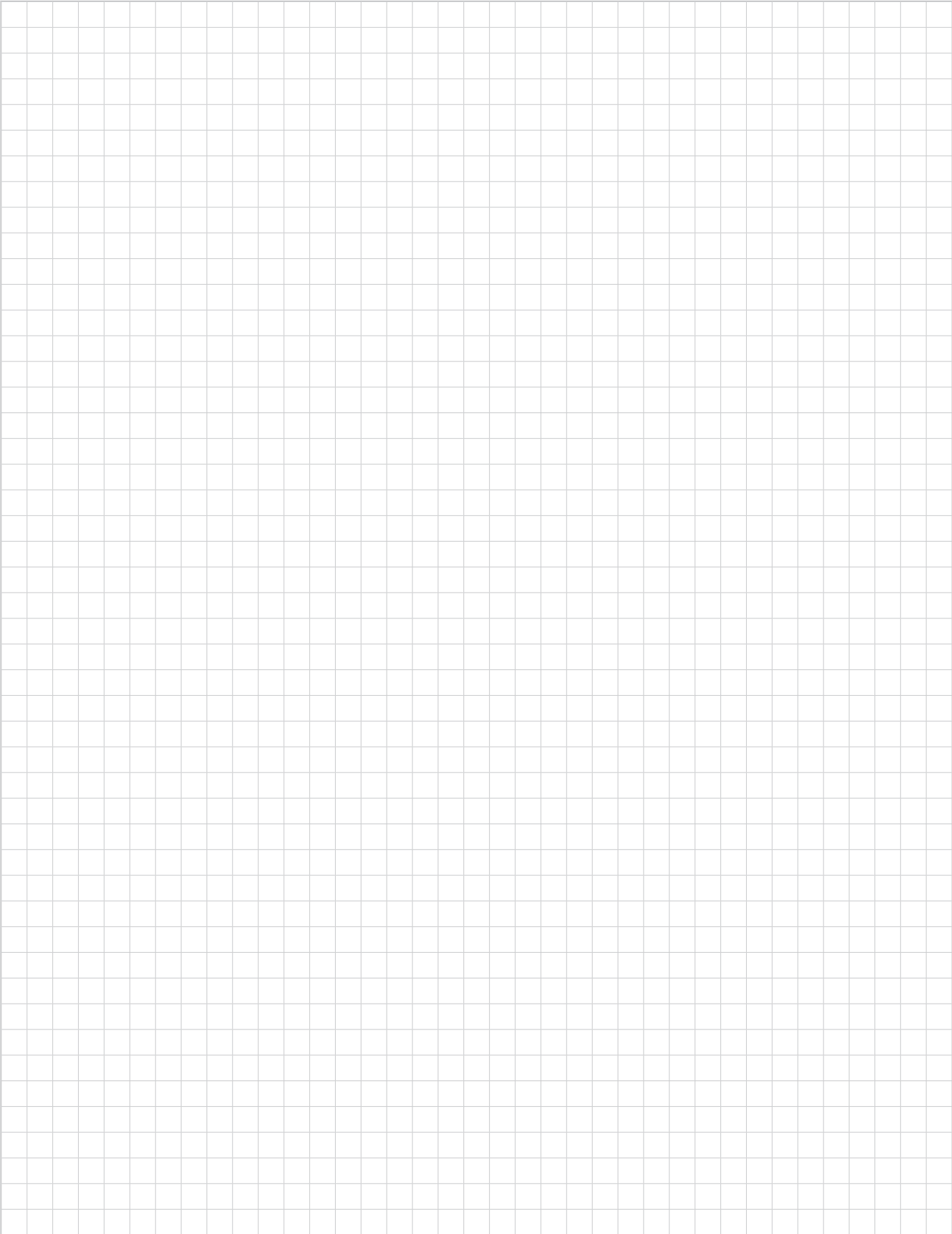

dimensions 50 x 40 x 10mm
to
235 x 174 x 12mm

through-beam fork width 20mm
30mm
50mm
80mm
150mm

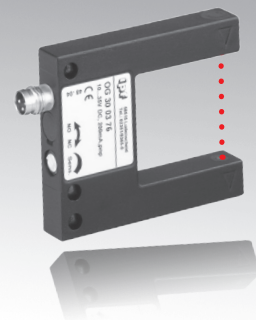
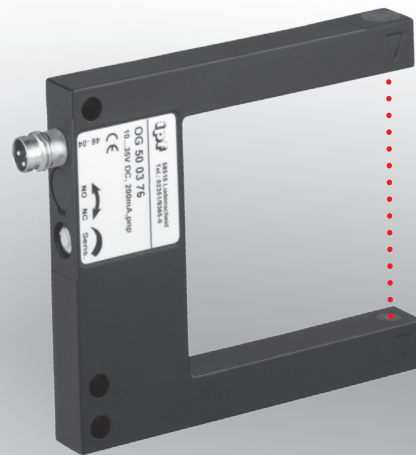

- ✓ robust metal housing
- ✓ easy mounting and high degree of protection
- ✓ LED display (signal)
- ✓ adjustable sensitivity
- ✓ integrated amplifier
- ✓ high switching frequency

**increased contamination reserve
ext. light shielding through infrared light**



description

The transmitter, receiver and all of the electronics can be found in one housing, thus ensuring the easiest and quickest installation possible. The forked light barriers in this series work using pulsed infrared light which provides very good external light shielding.

Thanks to the powerful light beam objects can be detected e.g. through transparent foils.

The interruption of the light beam is converted into a switch signal by the integrated amplifier.

The sensitivity can be adjusted using the integrated potentiometer.

High resolution and a short response time ensure the most accurate positioning possible as well as accurate detection of the fastest movements.

application examples

- ▶ part detection in feed rails
- ▶ quality assurance in automated production processes
- ▶ position switches or limit value sensors in machines and in automated production processes
- ▶ pulse generators for triggering counters, rotation speed monitors, linear and angle measurement devices

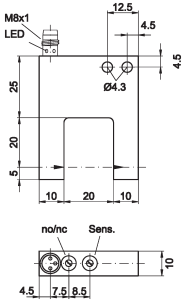
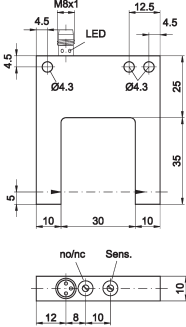

article-no.	OG200376	OG300376
fork width	20mm	30mm
transmitting element (pulsed)	infrared	infrared
		
TECHNICAL DATA		
fork width	20mm	30mm
resolution *	Ø 2mm	Ø 3mm
output	pnp, no / nc	pnp, no / nc
operating voltage	10 ... 35V DC	10 ... 30V DC
current consumption (w/o load)	< 30mA	< 30mA
output current (max. load)	200mA	200mA
voltage drop (max. load)	2.8V DC	2.8V DC
hysteresis	0.1mm	0.2mm
repeat accuracy	0.02mm	0.02mm
transmitting element (pulsed)	infrared	infrared
wavelength	880nm	880nm
switching frequency	300Hz	300Hz
display (signal)	yellow LED	yellow LED
sensitivity adjustment	potentiometer	potentiometer
short-circuit protection	+	+
reverse polarity protection	+	+
housing material	zinc diecast	zinc diecast
dimensions	50x40x10mm	60x50x10mm
operating temperature	-10 ... +60°C	-10 ... +60°C
degree of protection (EN 60529)	IP67	IP67
connection	M8-connector, 3-pin	M8-connector, 3-pin
connection accessories	e.g. VK200075	e.g. VK200075
* smallest detectable object		

article-no.	OG500376	OG800376
fork width	50mm	80mm
transmitting element (pulsed)	infrared	infrared
TECHNICAL DATA		
fork width	50mm	80mm
resolution *	Ø 3mm	Ø 3.0mm
output	npn, no / nc	npn, no / nc
operating voltage	10 ... 30V DC	10 ... 30V DC
current consumption (w/o load)	< 30mA	< 30mA
output current (max. load)	200mA	200mA
voltage drop (max. load)	2.8V DC	2.8V DC
hysteresis	0.2mm	0.2mm
repeat accuracy	0.02mm	0.02mm
transmitting element (pulsed)	infrared	infrared
wavelength	880nm	880nm
switching frequency	300Hz	300Hz
display (signal)	yellow LED	yellow LED
sensitivity adjustment	potentiometer	potentiometer
short-circuit protection	+	+
reverse polarity protection	+	+
housing material	zinc diecast	zinc diecast
dimensions	80x70x10mm	80x100x10mm
operating temperature	-10 ... +60°C	-10 ... +60°C
degree of protection (EN 60529)	IP67	IP67
connection	M8-connector, 3-pin	M8-connector, 3-pin
connection accessories	e.g. VK200075	e.g. VK200075
* smallest detectable object		



NOTES

A large grid area for taking notes, consisting of a 30x30 grid of small squares. The grid is empty and occupies the majority of the page below the 'NOTES' header.

dimensions **75 x 105 x 15mm**

through-beam fork width **50mm**

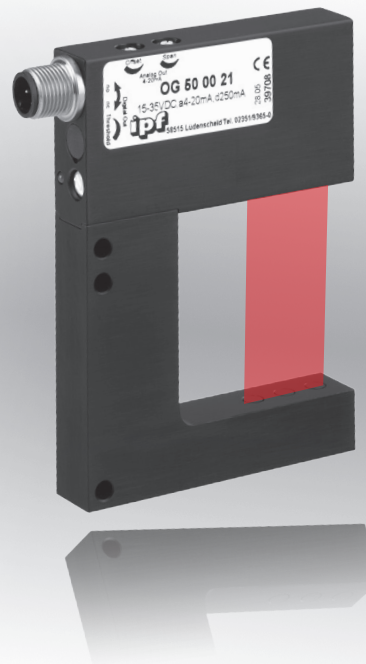

- ✓ **robust metal housing**
- ✓ **easy mounting and high degree of protection**
- ✓ **LED display (signal)**
- ✓ **adjustable sensitivity**
- ✓ **integrated amplifier**
- ✓ **high switching frequency**

analog output 4 ... 20mA
ext. light shielding through infrared light

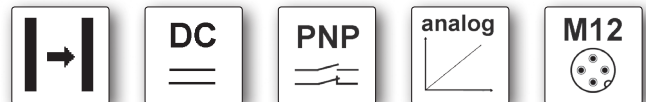

3

description

The transmitter, receiver and all of the electronics can be found in one housing, thus ensuring the easiest and quickest installation possible. The device works with pulsed infrared light. The interruption of the light beam is converted into a switch signal by the integrated amplifier. In addition, a current signal is output whose current is proportional to the percentage coverage of the light band.

The sensitivity and/or the set-point can be adjusted using the integrated potentiometer.

application examples

- ▶ web edge guide control
- ▶ height control

article-no.	OG500021
fork width	50mm
transmitting element (pulsed)	infrared
output	pnp, no / nc analog 4 ... 20mA

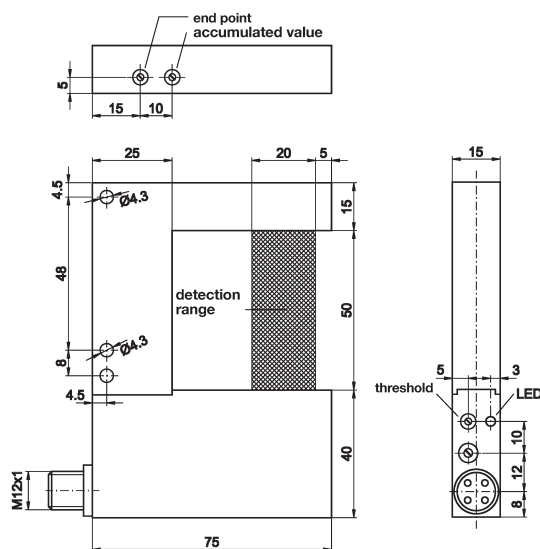

TECHNICAL DATA

fork width	50mm
resolution *	Ø 0.5mm
output	pnp, no / nc analog 4 ... 20mA
operating voltage	15 ... 35V DC
current consumption (w/o load)	≤ 50mA
output current (max. load)	200mA
voltage drop (max. load)	2.8V DC
load resistance max.	500Ω
hysteresis	switching output 10%
repeat accuracy	0.05mm
linearity deviation	5%
temperature drift	0.5%/K
transmitting element (pulsed)	infrared
wavelength	880nm
switching frequency	2kHz, depending on set threshold
display (signal)	yellow LED
sensitivity adjustment	potentiometer
short-circuit protection	+
reverse polarity protection	+
housing material	zinc
dimensions	75x105x15mm
operating temperature	+5 ... +50°C
degree of protection (EN 60529)	IP67
connection	M12-connector, 4-pin
connection accessories	e.g. VK200325

* smallest detectable object

article-no.	OG300375	OG500375
fork width	30mm	50mm
transmitting element (pulsed)	infrared	infrared

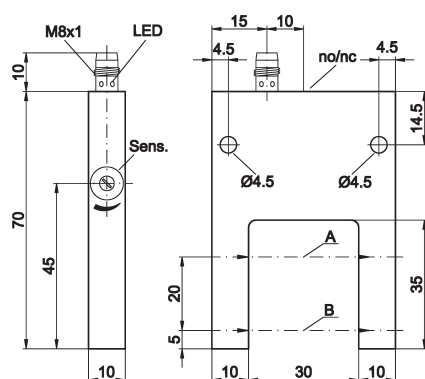

A=reference beam (free) B=measuring beam

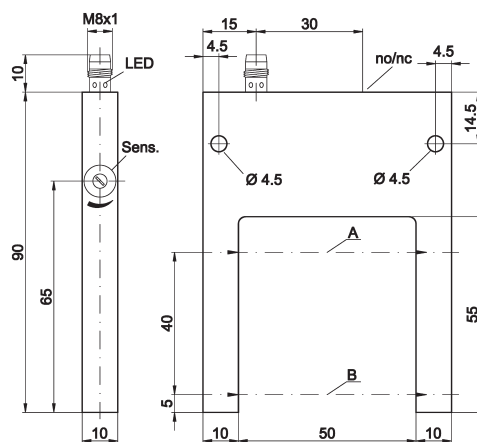

A=reference beam (free) B=measuring beam

TECHNICAL DATA

fork width	30mm	50mm
resolution *	Ø 0.07mm	Ø 0.1mm
output	npn, no / nc	npn, no / nc
operating voltage	12 ... 35V DC	12 ... 35V DC
current consumption (w/o load)	< 35mA	< 35mA
output current (max. load)	200mA	200mA
voltage drop (max. load)	2.5V DC	2.5V DC
hysteresis	0.2mm	0.2mm
repeat accuracy	0.01mm	0.01mm
transmitting element (non-pulsed)	infrared	infrared
wavelength	880nm	880nm
switching frequency	5kHz	5kHz
display (signal)	yellow LED	yellow LED
sensitivity adjustment	potentiometer	potentiometer
short-circuit protection	+	+
reverse polarity protection	+	+
housing material	aluminum	aluminum
dimensions	70x50x10mm	90x70x10mm
operating temperature	0 ... +60°C	0 ... +60°C
degree of protection (EN 60529)	IP67	IP67
connection	M8-connector, 3-pin	M8-connector, 3-pin
connection accessories	e.g. VK200075	e.g. VK200075

* smallest detectable object

article-no.	OG900375
fork width	90mm
transmitting element (pulsed)	infrared

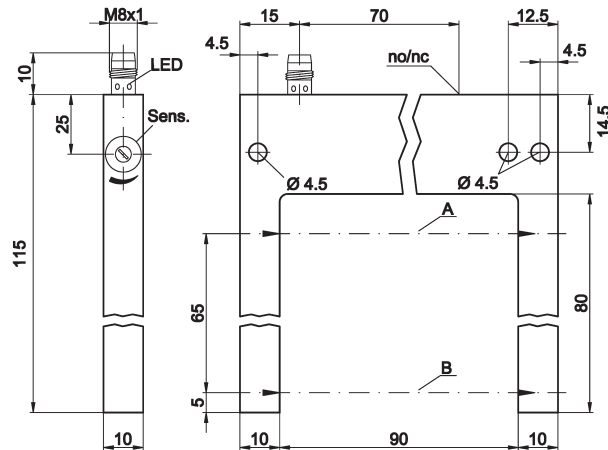

A=reference beam (free) B=measuring beam

TECHNICAL DATA

fork width	90mm
resolution *	Ø 0.25mm
output	npn, no / nc
operating voltage	12 ... 35V DC
current consumption (w/o load)	≤ 35mA
output current (max. load)	200mA
voltage drop (max. load)	2.5V DC
hysteresis	0.2mm
repeat accuracy	0.01mm
transmitting element (non-pulsed)	infrared
wavelength	880nm
switching frequency	5kHz
display (signal)	yellow LED
sensitivity adjustment	potentiometer
short-circuit protection	+
reverse polarity protection	+
housing material	aluminum
dimensions	115x110x10mm
operating temperature	0 ... +60°C
degree of protection (EN 60529)	IP67
connection	M8-connector, 3-pin
connection accessories	e.g. VK200075

* smallest detectable object



NOTES

A large grid area for taking notes, consisting of a 20x30 grid of small squares. The grid is empty and occupies the majority of the page below the 'NOTES' header.

article-no.	PG300370	PG300375
fork width	30mm	30mm
version	high resolution	standard
transmitting element (pulsed)	laser diode, red light	laser diode, red light

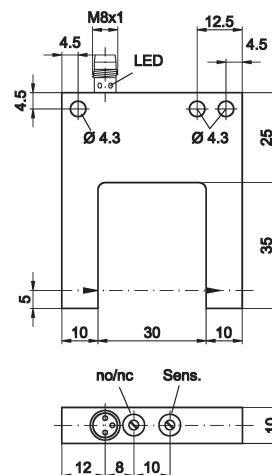
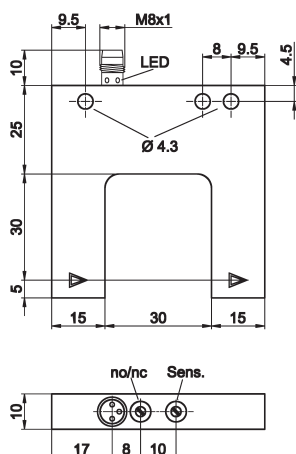

TECHNICAL DATA

fork width	30mm	30mm
resolution *	Ø 0.05mm	Ø 0.1mm
output	npn, no / nc	npn, no / nc
operating voltage	10 ... 30V DC	10 ... 35V DC
current consumption (w/o load)	< 30mA	< 30mA
output current (max. load)	200mA	200mA
voltage drop (max. load)	2.8V DC	2.8V DC
hysteresis	0.02mm	0.05mm
repeat accuracy	0.01mm	0.02mm
transmitting element (pulsed)	laser diode, red light	laser diode, red light
wavelength	670nm	670nm
laser class	2	2
switching frequency	3kHz	3kHz
display (signal)	yellow LED	yellow LED
sensitivity adjustment	potentiometer	potentiometer
short-circuit protection	+	+
reverse polarity protection	+	+
housing material	aluminum	zinc
dimensions	60x60x10mm	60x50x10mm
operating temperature	+5 ... +45°C	0 ... +50°C
degree of protection (EN 60529)	IP67	IP67
connection	M8-connector, 3-pin	M8-connector, 3-pin
connection accessories	e.g. VK200075	e.g. VK200075

* smallest detectable object

article-no.	PG500370	PG500375
fork width	50mm	50mm
version	high resolution / width 80mm	standard / width 70mm
transmitting element (pulsed)	laser diode, red light	laser diode, red light
TECHNICAL DATA		
fork width	50mm	50mm
resolution *	Ø 0.05mm	Ø 0.1mm
output	npn, no / nc	npn, no / nc
operating voltage	10 ... 30V DC	10 ... 35V DC
current consumption (w/o load)	< 30mA	< 30mA
output current (max. load)	200mA	200mA
voltage drop (max. load)	2.8V DC	2.8V DC
hysteresis	0.02mm	0.05mm
repeat accuracy	0.01mm	0.02mm
transmitting element (pulsed)	laser diode, red light	laser diode, red light
wavelength	670nm	670nm
laser class	2	2
switching frequency	3kHz	3kHz
display (signal)	yellow LED	yellow LED
sensitivity adjustment	potentiometer	potentiometer
short-circuit protection	+	+
reverse polarity protection	+	+
housing material	aluminum	zinc
dimensions	80x80x10mm	80x70x10mm
operating temperature	+5 ... +45°C	0 ... +50°C
degree of protection (EN 60529)	IP67	IP67
connection	M8-connector, 3-pin	M8-connector, 3-pin
connection accessories	e.g. VK200075	e.g. VK200075
* smallest detectable object		



article-no.	PG800370	PG800375
fork width	80mm	80mm
version	high resolution	standard
transmitting element (pulsed)	laser diode, red light	laser diode, red light

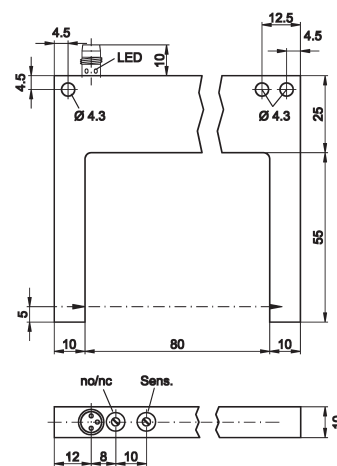
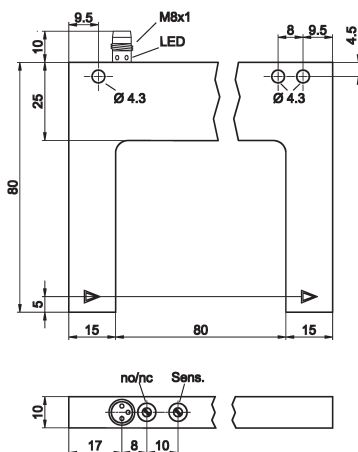

TECHNICAL DATA

fork width	80mm	80mm
resolution *	Ø 0.05mm	Ø 0.2mm
output	npn, no / nc	npn, no / nc
operating voltage	10 ... 30V DC	10 ... 35V DC
current consumption (w/o load)	< 30mA	< 30mA
output current (max. load)	200mA	200mA
voltage drop (max. load)	2.8V DC	2.8V DC
hysteresis	0.02mm	0.05mm
repeat accuracy	0.01mm	0.02mm
transmitting element (pulsed)	laser diode, red light	laser diode, red light
wavelength	670nm	670nm
laser class	2	2
switching frequency	3kHz	3kHz
display (signal)	yellow LED	yellow LED
sensitivity adjustment	potentiometer	potentiometer
short-circuit protection	+	+
reverse polarity protection	+	+
housing material	aluminum	zinc
dimensions	80x110x10mm	80x100x10mm
operating temperature	+5 ... +45°C	+0 ... +50°C
degree of protection (EN 60529)	IP67	IP67
connection	M8-connector, 3-pin	M8-connector, 3-pin
connection accessories	e.g. VK200075	e.g. VK200075

* smallest detectable object

article-no.	PGKB0370	PGKB0375
fork width	120mm	120mm
version	high resolution	standard
transmitting element (pulsed)	laser diode, red light	laser diode, red light
TECHNICAL DATA		
fork width	120mm	120mm
resolution *	Ø 0.05mm	Ø 0.2mm
output	npn, no / nc	npn, no / nc
operating voltage	10 ... 30V DC	10 ... 35V DC
current consumption (w/o load)	< 30mA	< 30mA
output current (max. load)	200mA	200mA
voltage drop (max. load)	2.8V DC	2.8V DC
hysteresis	0.02mm	0.05mm
repeat accuracy	0.01mm	0.02mm
transmitting element (pulsed)	laser diode, red light	laser diode, red light
wavelength	670nm	670nm
laser class	2	2
switching frequency	3kHz	3kHz
display (signal)	yellow LED	yellow LED
sensitivity adjustment	potentiometer	potentiometer
short-circuit protection	+	+
reverse polarity protection	+	+
housing material	zinc	zinc
dimensions	90x150x12mm	90x144x12mm
operating temperature	+5 ... +45°C	0 ... +50°C
degree of protection (EN 60529)	IP67	IP67
connection	M8-connector, 3-pin	M8-connector, 3-pin
connection accessories	e.g. VK200075	e.g. VK200075
* smallest detectable object		



connection

3-pin PNP, no

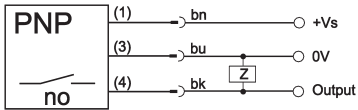

3-pin PNP, no/nc

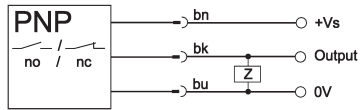

push-pull

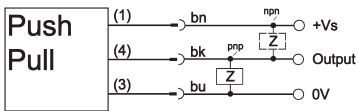

4-pin PNP, no, analog output

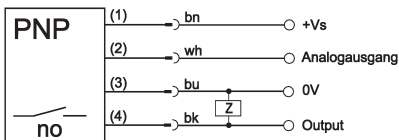

4-pin PNP, no/nc, remote-teach-input

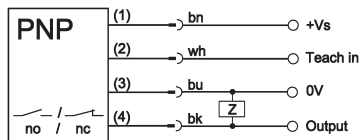

teaching operation: connect teach-in with +Vs
key lock function: connect teach-in with 0V

wire colors: bn = brown (1), wh = white (2), bu = blue (3), bk = black (4)

applications

object detection

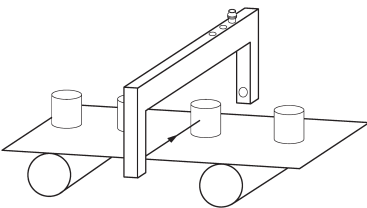

print-mark recognition

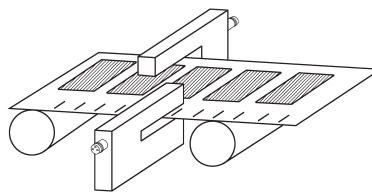

web edge guide control

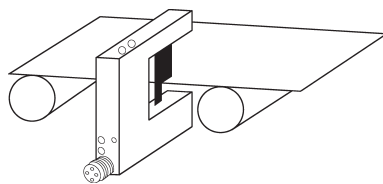

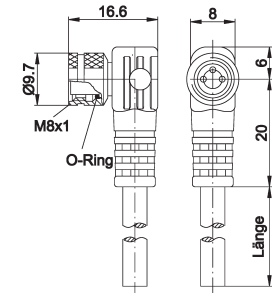
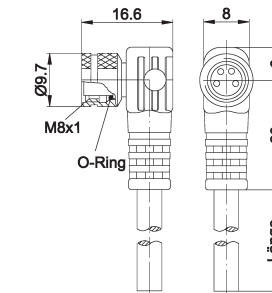
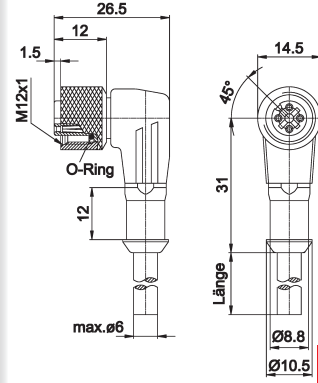
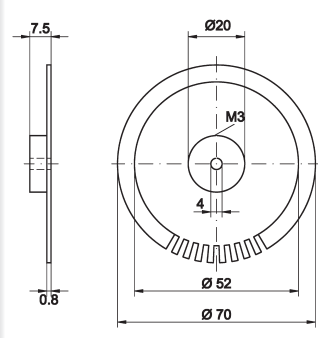
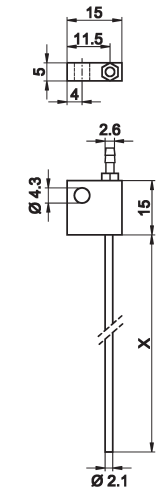
cable socket: number of pins (assigned):	M8, angular 3-pin	M8, angular 4-pin	M12, angular 4-pin
article-no.	VK200071	VK200371	VK200321
length	2m	2m	2m
article-no.	VK500071	VK500371	VK500321
length	5m	5m	5m
article-no.	VKA00071	VKA00371	VKA00321
length	10	10m	10m
			
CODE DISC		AIR PURGE	
article-no.	AO000059	article-no.	AO000099
code disc	100 pulses	pipe length (X)	60mm
article-no.		article-no.	AO000100
code disc		pipe length (X)	110mm
			

NOTES

A large grid area for taking notes, consisting of a 20x30 grid of small squares. The grid is empty and occupies the central portion of the page.