

dimensions	<b>12.9 x 32.3 x 23mm</b>	
dif. reflection sensor	sensing range	<b>up to 300mm</b>
retro-reflective sensor	operating range	<b>up to 5m</b>
auto-reflective sensor	operating range	<b>up to 300mm</b>

- ✓ plastic housing, compact design
- ✓ setting via teach-in
- ✓ LED-display with setting control
- ✓ retro-reflective sensor with polarizing filter
- ✓ auto-reflective sensor operates without retro-reflector
- ✓ suppression of mutual interference
- ✓ M8-connector, 4-pin

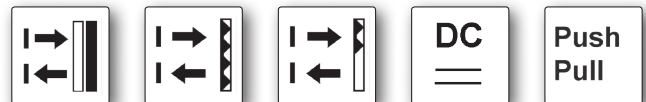

**wear-free teach-in function**  
**1 housing: 3 sensor principles**



**description**

The sensors of the **33** series are characterized by a convenient and reliable teach process and simple operation.

One housing shape with three different sensor principles.

1. Diffuse reflection sensor with background suppression for precise and color-independent detection.
2. Retro-reflective sensor with large operating range, also for the recognition of objects with reflective surfaces.
3. Auto-reflective sensor without reflector. The operating principle of these devices is similar to that of a retro-reflective sensor, except that instead of a reflector that is sensitive to soiling, an arbitrary, diffuse-reflecting object is used as reference surface. A metal part is best suited for this.

With these sensors, a new, convenient and wear-free teach process is presented.

To teach the sensors, it suffices to touch with any ferromagnetic tool.

A blue LED light provides clear optical feedback. To prevent tampering, the function locks automatically after 5 minutes.

Expanded performance reserves for reliable operation under

demanding conditions ensure reliable start up.

A pin-point-LED (point-shaped) is used as transmitting element on some devices. This makes the sensors suitable for the precise positioning and detection of small parts.

Optoelectronic sensors are indispensable components in all automated production processes. They are used in all applications where parts are to be detected, counted or positioned in a way which does not involve contact and which is reliable and fast.

To avoid mutual optical interference, the devices feature interference suppression. As a result, it is possible to mount sensor upon sensor without causing erroneous operations.

**application examples**

- ▶ distance control
- ▶ position recognition
- ▶ color-independent object recognition
- ▶ recognition of transparent objects

article-no.	OT330570	OT330571
version	diffuse reflection sensor background suppression	diffuse reflection sensor background suppression, point-shaped
sensing range	30 ... 300mm	30 ... 200mm
<b>TECHNICAL DATA</b>		
sensing range	30 ... 300mm	30 ... 200mm
output signal	push-pull, light-on/dark-on mode	push-pull, light-on/dark-on mode
operating voltage	10 ... 30V DC	10 ... 30V DC
current consumption (w/o load)	≤ 30mA	≤ 30mA
output current (max. load)	100mA	100mA
voltage drop (max. load)	3.0V DC	3.0V DC
transmitting element (pulsed)	LED, red light	LED, red light, point-shaped
wavelength	630nm	630nm
response/decay time	1.0ms	0.5ms
sampling frequency	500Hz	1kHz
display (operation)	green LED	green LED
display (signal)	yellow LED	yellow LED
display (alignment mark)	yellow LED, flashing	yellow LED, flashing
display (teach)	blue LED	blue LED
switch-point setting	with the help of a ferromagnetic tool	with the help of a ferromagnetic tool external
short-circuit protection	+	+
reverse polarity protection	+	+
interference suppression	+	+
dimensions	12.9x32.3x23mm	12.9x32.3x23mm
housing material	plastic (ASA, MABS)	plastic (ASA, MABS)
front screen material	PMMA	PMMA
operating temperature	-25 ... +60°C	-25 ... +60°C
degree of protection (EN 60529)	IP67	IP67
connection	M8-connector, 4-pin	M8-connector, 4-pin
connection accessories	e.g. <b>VK200375</b>	e.g. <b>VK200375</b>
accessories (universal holder)	<b>AY000118</b>	<b>AY000118</b>

article-no.	OR330571	ON330571
version	retro-reflective sensor polarizing filter, point-shaped	auto-reflective sensor no reflector, point-shaped
sensing range	5m	30 ... 300mm
<b>TECHNICAL DATA</b>		
sensing range	5m	30 ... 300mm
output signal	push-pull, light-on/dark-on mode	push-pull, light-on/dark-on mode
operating voltage	10 ... 30V DC	10 ... 30V DC
current consumption (w/o load)	≤ 25mA	≤ 30mA
output current (max. load)	100mA	100mA
voltage drop (max. load)	3.0V DC	3.0V DC
transmitting element (pulsed)	LED, red light, point-shaped	LED, red light, point-shaped
wavelength	630nm	630nm
response/decay time	0.5ms	0.5ms
sampling frequency	1kHz	1kHz
display (operation)	green LED	green LED
display (signal)	yellow LED	yellow LED
display (alignment mark)	yellow LED, flashing	yellow LED, flashing
display (teach)	blue LED	blue LED
switch-point setting	with the help of a ferromagnetic tool external	with the help of a ferromagnetic tool external
short-circuit protection	+	+
reverse polarity protection	+	+
interference suppression	+	+
dimensions	12.9x32.3x23mm	12.9x32.3x23mm
housing material	plastic (ASA, MABS)	plastic (ASA, MABS)
front screen material	PMMA	PMMA
operating temperature	-25 ... +60°C	-25 ... +60°C
degree of protection (EN 60529)	IP67	IP67
connection	M8-connector, 4-pin	M8-connector, 4-pin
connection accessories	e.g. <b>VK200375</b>	e.g. <b>VK200375</b>
accessories (universal holder)	<b>AY000118</b>	<b>AY000118</b>

### connection

standard version

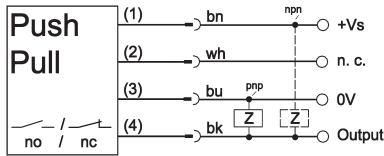

**wire colors:** bn = brown (1), wh = white (2), bu = blue (3), bk = black (4)  
do not connect pnp / npn simultaneously!

version with teach-in by wire

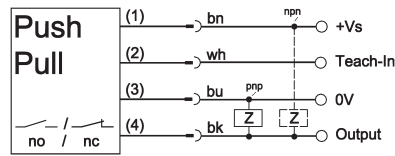

### beam path

OT330570

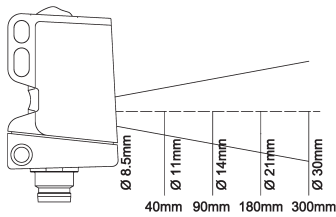

OT330571

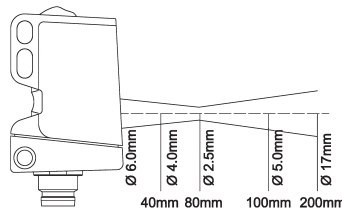

OR330571

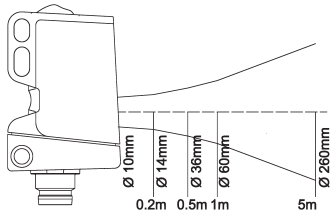

ON330571

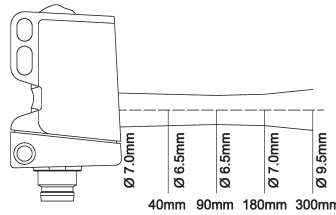

### universal holder AY000118

consisting of base module ...

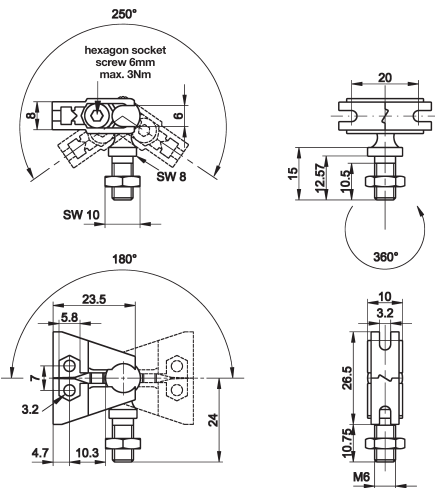

... and fitting panel

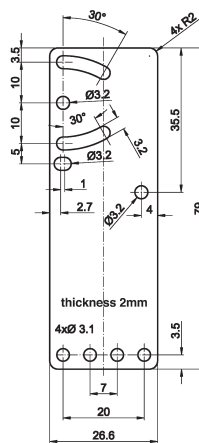

### ACCESSORIES

article-no.	description	note
AY000088	base module *	jaw: stainless steel, ball pin: galvanized steel
AY000118	mounting kit for sensors in design 33	stainless steel

\* The AY000088 base module is contained in every mounting kit. Material of bolts and nuts: galvanized steel.

This data sheet contains the standard versions only. Kindly request the availability of other output- and connection functions.

We will be pleased to supply the matching cable socket for your devices with connector. Please refer to the list in catalog chapter „accessories“ under „cable sockets ipf-SENSORFLEX®“ or search our website for „VK“.

Warning: Never use these devices in applications where the safety of a person depends on their functionality.

This data sheet as well as your personal contact can be found at [www.ipf-electronic.com](http://www.ipf-electronic.com)