

dimensions	18 x 56.2 x 32.2mm	
dif. reflection sensor	sensing range	up to 600mm
retro-reflective sensor	operating range	up to 7.5m
auto-reflective sensor	operating range	up to 600mm

- ✓ plastic housing, compact design
- ✓ setting via teach-in
- ✓ LED-display with setting control
- ✓ retro-reflective sensor with polarizing filter
- ✓ auto-reflective sensor functions without retro-reflector
- ✓ suppression of mutual interference
- ✓ M12-connector 4-pin

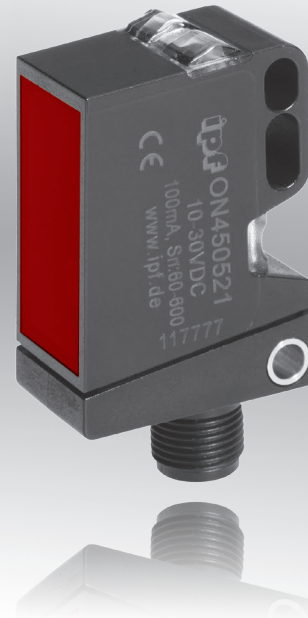

wear-free teach-in function
1 housing: 3 sensor principles

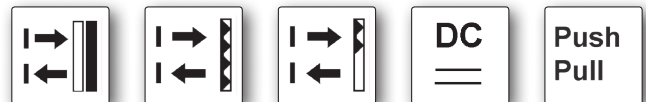

description

The sensors of the 45 series are characterized by a convenient and reliable teach process and simple operation.

One housing shape with three different sensor principles.

1. Diffuse reflection sensor with background suppression for precise and color-independent detection.
2. Retro-reflective sensor with large operating range, also for the recognition of objects with reflective surfaces.
3. Auto-reflective sensor without reflector. The operating principle of these devices is similar to that of a retro-reflective sensor, except that instead of a reflector that is sensitive to soiling, an arbitrary, diffuse-reflecting object is used as reference surface. A metal part is best suited for this.

With these sensors, a new, convenient and wear-free teach process is presented.

To teach the sensors, it suffices to touch with any ferromagnetic tool.

A blue LED light provides clear optical feedback. To prevent tampering, the function locks automatically after 5 minutes.

Expanded performance reserves for reliable operation under

demanding conditions ensure reliable start up.

A pin-point-LED (point-shaped) is used as transmitting element on some devices. This makes the sensors suitable for the precise positioning and detection of small parts.

Optoelectronic sensors are indispensable components in all automated production processes. They are used in all applications where parts are to be detected, counted or positioned in a way which does not involve contact and which is reliable and fast.

To avoid mutual optical interference, the devices feature interference suppression. As a result, it is possible to mount sensor upon sensor without causing erroneous operations.

application examples

- ▶ distance control
- ▶ position recognition
- ▶ color-independent object recognition
- ▶ recognition of transparent objects

article-no.	OT450520	OT450521
version	diffuse reflection sensor background suppression	diffuse reflection sensor background suppression, point-shaped
sensing range	30 ... 600mm	30 ... 400mm
TECHNICAL DATA		
sensing range	30 ... 600mm	30 ... 400mm
output signal	push-pull, light-on/dark-on mode	push-pull, light-on/dark-on mode
operating voltage	10 ... 30V DC	10 ... 30V DC
current consumption (w/o load)	≤ 30mA	≤ 30mA
output current (max. load)	100mA	100mA
voltage drop (max. load)	3.0V DC	3.0V DC
transmitting element (pulsed)	LED, red light	LED, red light, point-shaped
wavelength	630nm	630nm
response/decay time	1.0ms	0.5ms
sampling frequency	500Hz	1kHz
display (operation)	green LED	green LED
display (signal)	yellow LED	yellow LED
display (alignment mark)	yellow LED, flashing	yellow LED, flashing
display (teach)	blue LED	blue LED
switch-point setting	with the help of a ferromagnetic tool	with the help of a ferromagnetic tool external
short-circuit protection	+	+
reverse polarity protection	+	+
interference suppression	+	+
dimensions	18x56.2x32.2mm	18x56.2x32.2mm
housing material	plastic (ASA, MABS)	plastic (ASA, MABS)
front screen material	PMMA	PMMA
operating temperature	-25 ... +60°C	-25 ... +60°C
degree of protection (EN 60529)	IP67	IP67
connection	M12-connector, 4-pin	M12-connector, 4-pin
connection accessories	e.g. VK200325	e.g. VK200325
accessories (universal holder)	AY000138	AY000138

article-no. version	OR450521 retro-reflective sensor polarizing filter, point-shaped	ON450521 auto-reflective sensor no reflector, point-shaped
sensing range	7.5m	60 ... 600mm
TECHNICAL DATA		
sensing range	7.5m	60 ... 600mm
output signal	push-pull, light-on/dark-on mode	push-pull, light-on/dark-on mode
operating voltage	10 ... 30V DC	10 ... 30V DC
current consumption (w/o load)	≤ 30mA	≤ 30mA
output current (max. load)	100mA	100mA
voltage drop (max. load)	3.0V DC	3.0V DC
transmitting element (pulsed)	LED, red light	LED, red light, point-shaped
wavelength	630nm	630nm
response/decay time	0.5ms	0.5ms
sampling frequency	1kHz	1kHz
display (operation)	green LED	green LED
display (signal)	yellow LED	yellow LED
display (alignment mark)	yellow LED, flashing	yellow LED, flashing
display (teach)	blue LED	blue LED
switch-point setting	with the help of a ferromagnetic tool external	with the help of a ferromagnetic tool external
short-circuit protection	+	+
reverse polarity protection	+	+
interference suppression	+	+
dimensions	18x56.2x32.2mm	18x56.2x32.2mm
housing material	plastic (ASA, MABS)	plastic (ASA, MABS)
front screen material	PMMA	PMMA
operating temperature	-25 ... +60°C	-25 ... +60°C
degree of protection (EN 60529)	IP67	IP67
connection	M12-connector, 4-pin	M12-connector, 4-pin
connection accessories	e.g. VK200325	e.g. VK200325
accessories (universal holder)	AY000138	AY000138

connection

standard version

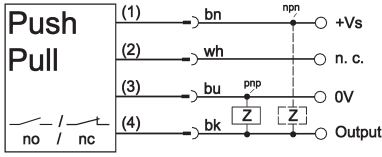

wire colors: bn = brown (1), wh = white (2), bu = blue (3), bk = black (4)
do not connect pnp / npn simultaneously!

version with teach-in by wire

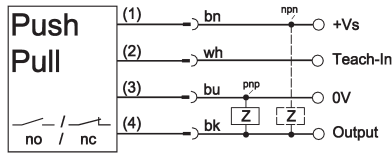

beam path

OT450520

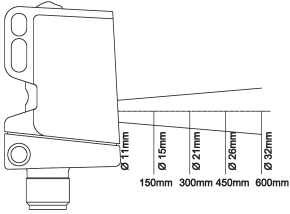

OT450521

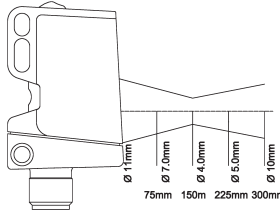

OR450521

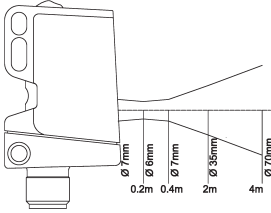

ON450521

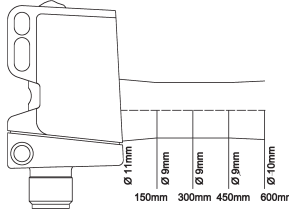

universal holder AY000118

consisting of base module ...

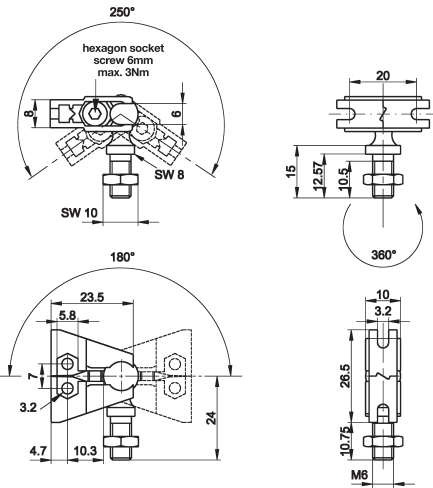

... and fitting panel

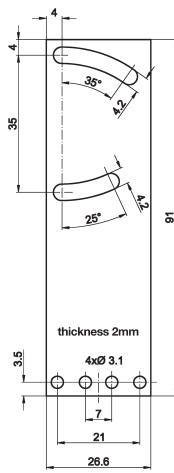

ACCESSORIES

article-no.	description	note
AY000088	base module *	jaw: stainless steel, ball pin: galvanized steel
AY000138	mounting kit for sensors in design 45	stainless steel

* The **AY000088** base module is contained in every mounting kit. Material of bolts and nuts: galvanized steel.

This data sheet contains the standard versions only. Kindly request the availability of other output- and connection functions.

We will be pleased to supply the matching cable socket for your devices with connector. Please refer to the list in catalog chapter „accessories“ under „cable sockets **ipf**-SENSORFLEX®“ or search our website for „VK“.

Warning: Never use these devices in applications where the safety of a person depends on their functionality.

This data sheet as well as your personal contact can be found at www.ipf-electronic.com