

design **M8x1**
 M12x1

version **straight**
 angular



- ✓ round pin connector with rapid interconnection technology
- ✓ M8 and M12 versions
- ✓ straight and angular versions
- ✓ easy assembly
- ✓ plastic and nickel-plated brass

ready-made cut&clamp connection



description

The tried and tested cut&clamp method of termination simplifies the connection of sensors and actuators. The connection method allows the „on-site“ connection of sensors, without having to deploy additional connectors. No special tools are needed for stripping the insulation off cables or for the screw fitting of components. This allows preferred sensor types with a fixed cable length to be tailored individually in the field. There are no annoying

excess cable loops to deal with, which also delivers savings in terms of time and costs. Multiple deployment is possible and the high requirements of protection class IP67 are complied with.

application examples

- ▶ pre-fabrication of connectors with fixed-cable devices or connection leads

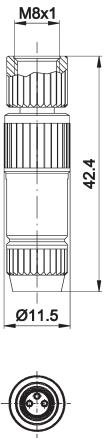
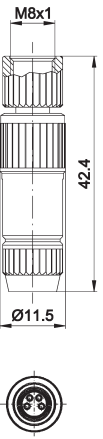
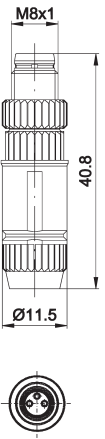
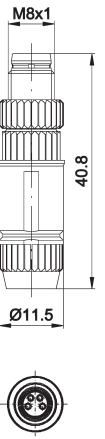
article-no.	VK003S74	VK003S75	VK003S78	VK003S79
version	M8-cable socket straight, 3-pin rapid interconnection	M8-cable socket straight, 4-pin rapid interconnection	M8-cable connector straight, 3-pin rapid interconnection	M8-cable connector straight, 4-pin rapid interconnection
				
TECHNICAL DATA				
rated voltage	32V DC	32V DC	32V DC	32V DC
rated current	4A	4A	4A	4A
wire diameter	0.14 ... 0.34mm ²	0.14 ... 0.34mm ²	0.14 ... 0.34mm ²	0.14 ... 0.34mm ²
strand diameter	≥ 0.1mm	≥ 0.1mm	≥ 0.1mm	≥ 0.1mm
wire isolation material	PVC	PVC	PVC	PVC
wire diameter	1.0 ... 1.6mm	1.0 ... 1.6mm	1.0 ... 1.6mm	1.0 ... 1.6mm
cable diameter	2.5 ... 5.1mm	2.5 ... 5.1mm	2.5 ... 5.1mm	2.5 ... 5.1mm
operating temperature	-25 ... +85°C	-25 ... +85°C	-25 ... +85°C	-25 ... +85°C
temp. when making the connect.	-5 ... +50°C	-5 ... +50°C	-5 ... +50°C	-5 ... +50°C
system of protection (EN 60529)	IP 67	IP 67	IP 67	IP 67
max. number of connections with identical cable diameters	10	10	10	10

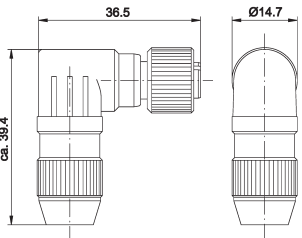
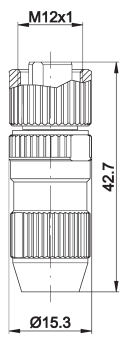
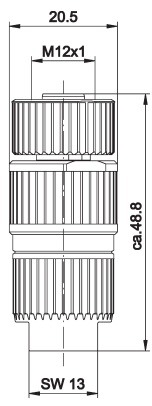
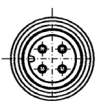
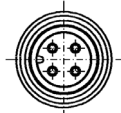
article-no. version	VK003D20 M12-cable socket angular, 4-pin rapid interconnection	VK003S24 M12-cable socket straight, 4-pin rapid interconnection	VK003D25 M12-cable socket straight, 4-pin rapid interconnection
			
			
TECHNICAL DATA			
rated voltage	32V DC	32V DC	50V DC
rated current	4A	4A	6A
wire diameter	0.25 ... 0.5mm ²	0.14 ... 0.34mm ²	0.34 ... 0.75mm ²
strand diameter	≥ 0.1mm	≥ 0.1mm	≥ 0.1mm
wire isolation material	PVC	PVC	PVC
wire diameter	1.2 ... 1.6mm	1.0 ... 1.6mm	1.6 ... 2.0mm
cable diameter	4.0 ... 5.1mm	4.0 ... 5.1mm	6.0 ... 8.0mm
operating temperature	-25 ... +85°C	-25 ... +85°C	-25 ... +85°C
temp. when making the connect.	-5 ... +50°C	-5 ... +50°C	-5 ... +50°C
system of protection (EN 60529)	IP 67	IP 67	IP 67
max. number of connections with identical cable diameters	10	10	10

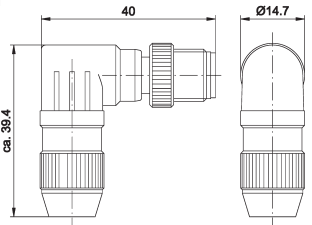
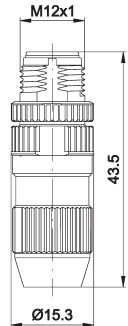
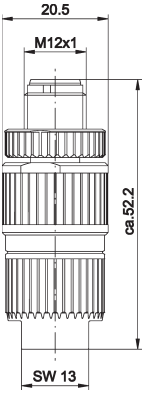
article-no. version	VK003D26 M12-cable socket angular, 4-pin rapid interconnection	VK003S28 M12-cable socket straight, 4-pin rapid interconnection	VK003D29 M12-cable socket straight, 4-pin rapid interconnection
			
TECHNICAL DATA			
rated voltage	32V DC	32V DC	50V DC
rated current	4A	4A	6A
wire diameter	0.25 ... 0.5mm ²	0.14 ... 0.34mm ²	0.34 ... 0.75mm ²
strand diameter	≥ 0.1mm	≥ 0.1mm	≥ 0.1mm
wire isolation material	PVC	PVC	PVC
wire diameter	1.2 ... 1.6mm	1.0 ... 1.6mm	1.2 ... 2.0mm
cable diameter	4.0 ... 5.1mm	4.0 ... 5.1mm	6.0 ... 8.0mm
operating temperature	-25 ... +85°C	-25 ... +85°C	-25 ... +85°C
temp. when making the connect.	-5 ... +50°C	-5 ... +50°C	-5 ... +50°C
system of protection (EN 60529)	IP 67	IP 67	IP 67
max. number of connections with identical cable diameters	10	10	10

assembly instructions

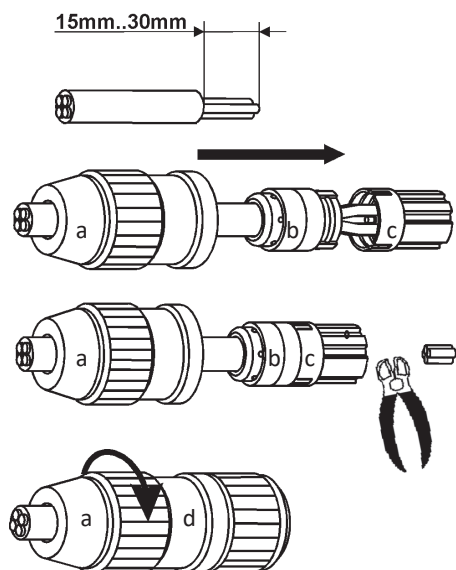

Pull sheath of the cable back in such a way that the individual wires will be showing by about 30mm.

Push coupling ring (a) over the cable. Push cable support sleeve (b) over the cable to touch the sheath of the cable. Push the individual wires through the white fitting sleeve (c) matching the color coding.

Note: With cable sockets the fitting sleeve (c) is colored white and with cable plugs it is grey. As the pin order for sockets is opposite to that for plugs, then any inversion will lead to a short-circuit in the sensor that is connected.

Push fitting sleeve (c) onto cable support sleeve (b) cutting off protruding parts of the individual wires, if any.

Push male or female connector (d) onto the fitting sleeve (c). The fins have been provided for positioning. Screw coupling ring (a) down on male or female connector.

Warning: Never use these devices in applications where the safety of a person depends on their functionality.

design	102 x 60 x 41.5mm	
	127 x 60 x 41.5mm	
	152 x 60 x 41.5mm	
	152 x 60 x 43mm	
version	4-way	5-pin
	6-way	5-pin
	8-way	5-pin



- ✓ flat, robust design
- ✓ plugable, connection module for bus, field-attachable
- ✓ 5-pin versions
- ✓ LED-status displays
- ✓ integrated plugable potential divider e.g. for sensor and actuator connection
- ✓ degree of protection IP67

sensor / actuator distributor also as robust metal version

M12

PNP

NPN

analog

description

Using *ipf*-sensor-actuator-distributors economizes on material, space, weight, money and time. The expenditure for configuring and installing the electronic wiring on machines and equipment is significantly reduced by a direct mounting when compared to the individual conventional wiring.

The application of ready-made connection cables (socket/connector) minimizes the time for replacing defective sensors and lines increasing the safety at the same time as wiring errors are avoided.

Consequently, *ipf*-sensor-actuator-distributors enable the integrated connection of sensors and actuators on the power supply and distributor sides. The 5-pin M12-connector of the plastic version feature two status LEDs to display the inputs and outputs.

The operating voltage is displayed by two green LEDs. In the metal version the status LEDs have been dispensed with, thus allowing the use also of analog sensors. Name plates ensure

clear assignment of the components.

The plug-in potential divider that has been integrated in the distributors enables the splitting up in two separate circuits, e.g. for the emergency cut-off applications or for the separation of sensor and actuator potential.

Each I/O channel can be loaded with up to 2A. The total current load is 10A with a one-way power supply and 16A with a two-way power supply.

ipf-sensor-actuator-distributors with permanent connection cables in several lengths complete our range of products. For this purpose kindly request our special data sheets.

application examples

- ▶ local collective distributor with vibration proof connection of sensors and actuators
- ▶ comfortable recommissioning of pre-testet machine parts thanks to easy connection after reconstruction

TECHNICAL DATA	
operating voltage	10 ... 30V DC
output current (max. load)	2A per I/O signal 10A with one-way, 2 x 8A with two-way supply
insulation resistance	> 10 ⁹ Ω
testing voltage	1.0kVeff
operation display	operating voltage: 2 x green LED
signal display	I/O: 1 x yellow LED per function (no I/O LED with metal version)
potential divider	via 2 bridge connector (see fig. 2)
housing material	plastic (PBT), metal (zinc diecast)
contact material	CuZn, nickel primer and gold-plated
inflammability class	UL 94 V-0
operating temperature	-20 ... +90°C
system of protection (EN 60529)	IP67
connection	plugable coupling-top with screw terminals and cable gland
cable diameter	max. 12mm (coupling VK000027: max. 14mm / coupling VK000028: max. 18mm)
contact plug-in / pull-out power	≥ 0.5N
plug-in cycles	max. 50
degree of soiling	3

fig. 1

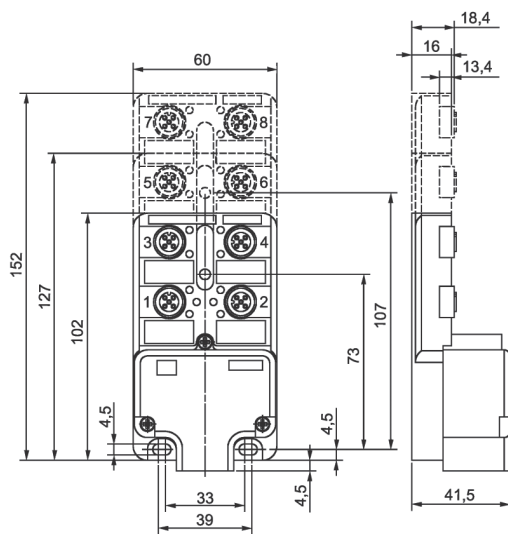
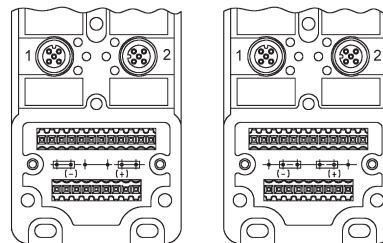

fig. 2

circuit programming
illustration without cap



bridged potential
(1 + 2 identical)

splitted potential
(1 / 2 divided)

wiring diagram
with cable **AV000085**

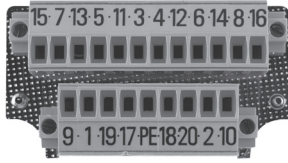

M12-socket

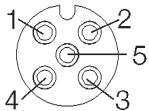

terminal marking	assignment (potential)
1	+ 24V DC
2	in-/output (2)
3	- 0V
4	in-/output (1)
5	PE

terminal	slot	input/output potential	wire colors	code
1	1	E/A 1-1	white	WH
2	2	E/A 2-1	green	GN
3	3	E/A 3-1	yellow	YE
4	4	E/A 4-1	grey	GY
5	5	E/A 5-1	pink	PK
6	6	E/A 6-1	red	RD
7	7	E/A 7-1	black	BK
8	8	E/A 8-1	purple	VT
9	1	E/A 1-2	grey-pink	GYPK
10	2	E/A 2-2	red-blue	RDBL
11	3	E/A 3-2	white-green	WHGN
12	4	E/A 4-2	brown-green	BNGN
13	5	E/A 5-2	white-yellow	WHYE
14	6	E/A 6-2	yellow-brown	YEBN
15	7	E/A 7-2	white-grey	WHGY
16	8	E/A 8-2	grey-brown	GYBN
17	1, 3, 5, 7	U1 + (24V DC)	brown	BN
18	1, 3, 5, 7	U1 - (0V)	blue	BU
19	2, 4, 6, 8	U2 + (24V DC)	red	RD
20	2, 4, 6, 8	U2 - (0V)	black	BK
21	1, 2, 3, 4, 5, 6, 7, 8	PE		

No potential divide between U1+ and U2+ for **VK000020**.

distributor-complete module and accessories

article-no.	design	description	note	housing	voltage	output	current	connection / note	fig.
VK000007	102x60x41.5	dist. with coupling	5-pin, 4-way	plastic	10-30V DC	pnp/npn	4 x 2A	coupling 21-pin, pluggable	1
VK000008	127x60x41.5	dist. with coupling	5-pin, 6-way	plastic	10-30V DC	pnp/npn	6 x 2A	coupling 21-pin, pluggable	1
VK000009	152x60x41.5	dist. with coupling	5-pin, 8-way	plastic	10-30V DC	pnp/npn	8 x 2A	coupling 21-pin, pluggable	1
VK000020	152x60x43	dist. with coupling	5-pin, 8-way	metal	10-30V DC	pnp/npn/analog	8 x 2A	coupling 21-pin, pluggable	1
VK000004	M12	blank plug	for distrib.	plastic				(2 x incl. in scope of delivery)	
VK000010	M12	label	for distrib.	plastic				(incl. in scope of delivery)	
AV000085		cable	for distrib.	PUR				16x0.34mm ² +3x0.75mm ²	
VK003028	M12	cable connector	central	plastic				screw connection, 4-pin	
VK003029	M12	cable connector	central	plastic				screw connection, 5-pin	

distributor base and separate coupling

article-no.	design	description	notes	housing	voltage	output	current	connection
VK000026	152x60x41.5	distrib. w/o coupling	5-pin, 8-way	plastic	10 ... 30V DC	pnp/npn	8 x 2A	w/o coupling
VK000027	for distributor	coupling M20	cable Ø10 ... 14mm	metal	10 ... 30V DC		max.8 x 2A	coupl. 21-pin, pluggable
VK000028	for distributor	coupling M25	cable Ø13 ... 18mm	metal	10 ... 30V DC		max.8 x 2A	coupl. 21-pin, pluggable

If an upward cable canal is needed, the thread is already primed.

This data sheet contains the standard versions only. Kindly request the availability of other output- and connection functions.

We will be pleased to supply the matching cable socket for your devices with connector. Please refer to the list in catalog chapter "accessories" under "cable sockets **ipf-SENSORFLEX®**" or search our website for "VK".

Warning: Never use these devices in applications where the safety of a person depends on their functionality.

NOTES

A large grid area for taking notes, consisting of a 20x30 grid of small squares. The grid is empty and occupies the majority of the page.