



Gooseneck series



LED gooseneck light, white light, 24VDC or 230VAC



Flexible use

The lights are suitable for stationary illumination of workstations, workbenches, assembly or inspection stations and machines. They can be specifically aligned on the right area as they have articulated or flexible arms and various mounting options. The versions with magnifiers are required for workstations or test stations where magnification with glare-free and shadow-free illumination is crucial.

Article No.	AO000318	AO000397	EB180170
			
ardSOCA_Abmessungen	Ø65mm, 400mm long	Ø65mm, 600mm long	M18x1, 250mm long
ardSOCA_Betriebsspannung	12-28VDC	12-28VDC	15-30VDC
Rated operating current	210 mA	210 mA	80 mA
Housing material	Aluminum	Aluminum	Stainless steel 1.4305
Ambient temperature	-20 - 40 °C	-20 - 40 °C	-20 - 50 °C
ardSOCA_ElektrischerAnschluss	M12 4-pin plug connector	M12 4-pin plug connector	M8 3-pin plug connector

Article No.	EB800120	EB804140
		
ardSOCA_Abmessungen	500x80mm	
ardSOCA_Betriebsspannung	24VDC	230VAC(50Hz)
Rated operating current	375 mA	40 mA
Housing material	Aluminum	
Ambient temperature	-10 - 40 °C	-10 - 50 °C
ardSOCA_ElektrischerAnschluss	M12 4-pin plug connector 3m	SCHUKO connector, straight 3-pin 3m

Anschlussbild_AO000318

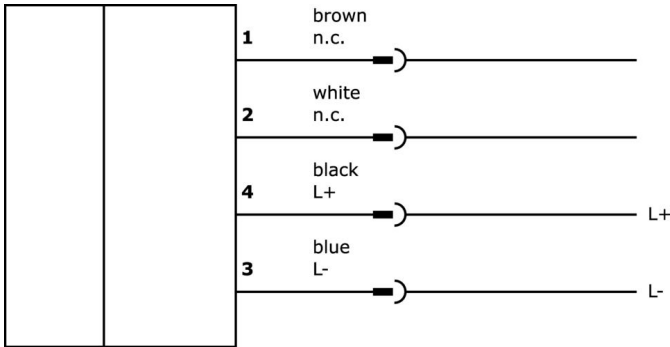

Anschlussbild_EB180170

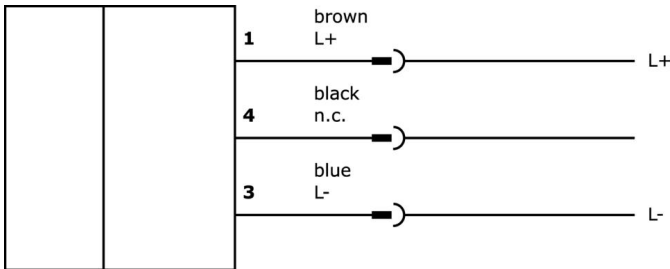

Anschlussbild_EB804140

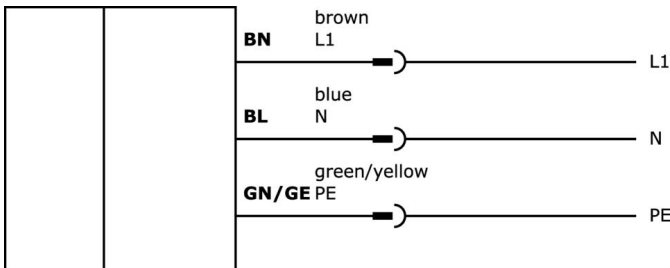

Dimensional drawing

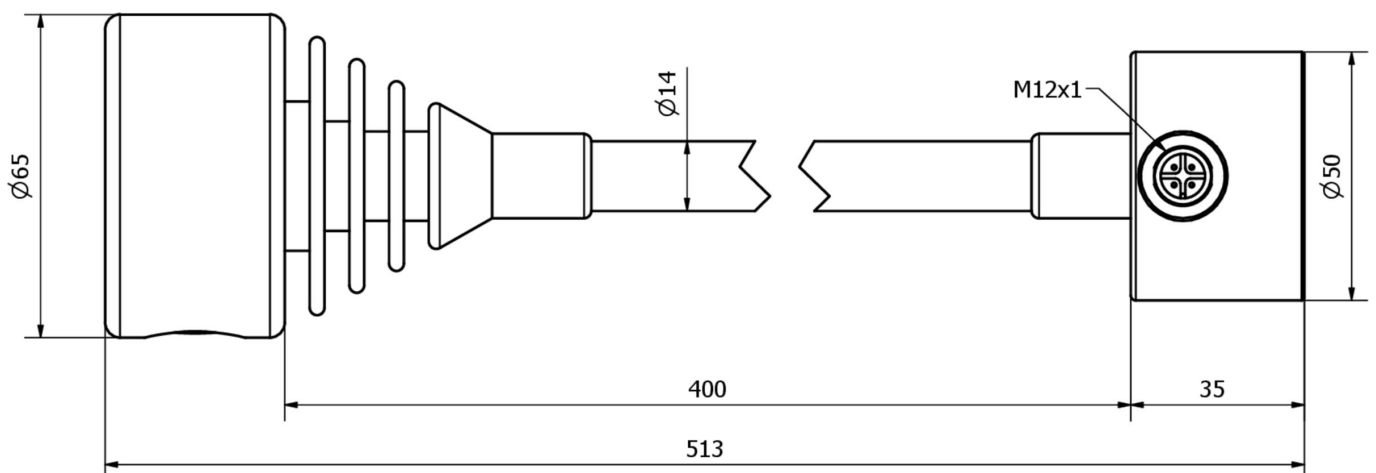

Dimensional drawing AO000318

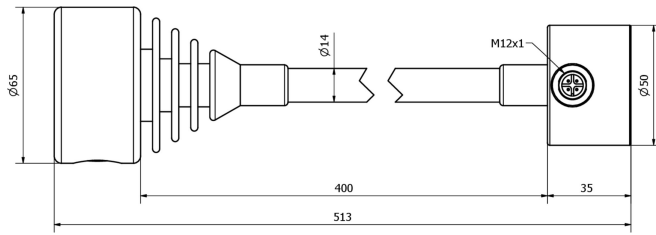

Dimensional drawing AO000397

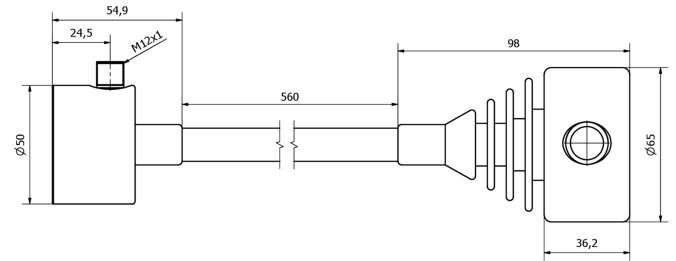

Dimensional drawing EB180170

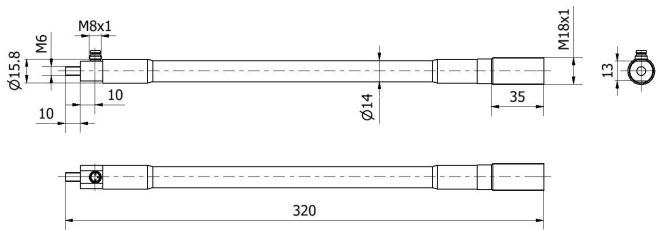

Dimensional drawing EB800120

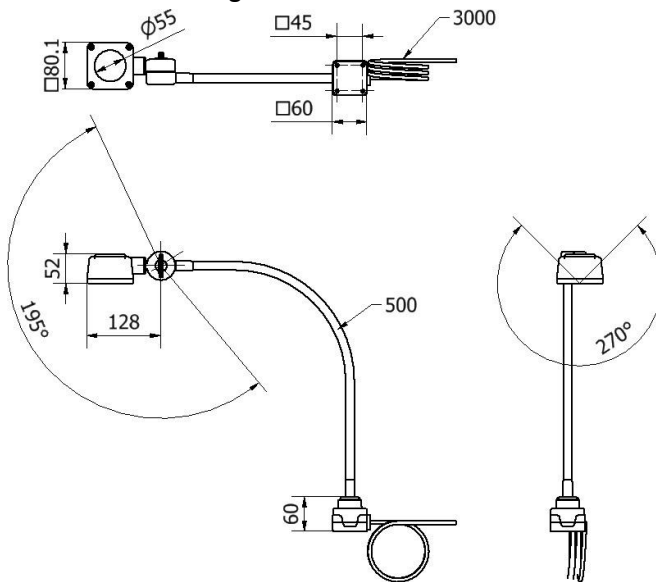

Dimensional drawing EB804140

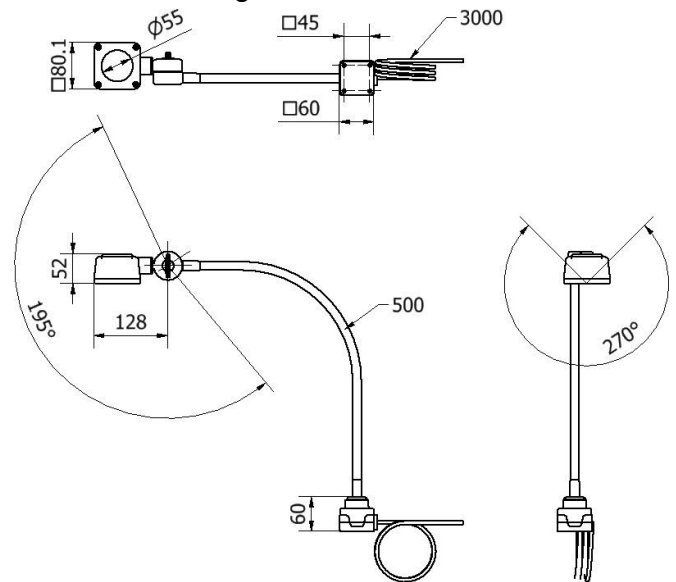

Extract accessories program

AY000131



accessories optical, Protection cap, 6mm high, Inner diameter 50mm, Rubber

VK200021



Connection cable, 2m, M12 Female (socket) 3pin Angular, Free conductor end, 3x0.34mm², PUR (Polyurethane), Ø4.3mm, 250V, -30-90°C, IP67, Suitable for trailing chain and torsion resistant, Oil and cooling lubricants, Welding area, Silicone-free

VK200025



Connection cable, 2m, M12 Female (socket) 3pin Straight, Free conductor end, 3x0.34mm², PUR (Polyurethane), Ø4.3mm, 250V, -30-90°C, IP67, Suitable for trailing chain and torsion resistant, Oil and cooling lubricants, Welding area, Silicone-free

VK030F60



Connection cable, 0.3m, M12 socket 3-pin angular, M8 connector 3-pin straight, 3x0.34mm², PUR (polyurethane), 60V, IP67, suitable for trailing chain and torsion resistant, oils and cooling lubricants, welding area, silicone-free

VK030F64



Connection cable, 0.3m, M12 socket 3-pin straight, M8 connector 3-pin straight, 3x0.34mm², PUR (polyurethane), 60V, IP67, suitable for trailing chain and torsion resistant, oils and cooling lubricants, welding area, silicone-free

VK003020



Cable socket, angular, self-assembly, screw connection, Ø3-6.5mm, 4A, 240V, -25-90°C, M12 socket 4-pin, IP67, PBT

VK003024



Cable socket, Straight, Suitable for self-assembly, Screw connection, Ø3-6.5mm, 4A, 240V, -25-90°C, M12 Female (socket) 4pin, IP67, PBT

VK003021



Cable socket, Angular, Suitable for self-assembly, Screw connection, Ø3-6.5mm, 4A, 60V, -25-90°C, M12 Female (socket) 5pin, IP67, PBT

VK003025



Cable socket, Straight, Suitable for self-assembly, Screw connection, Ø3-6.5mm, 4A, 60V, -25-90°C, M12 Female (socket) 5pin, IP67, PBT

You can find further accessories on our homepage



Installation

Mounting / installation may only be carried out by a qualified electrician!



Disposal

WEEE number according to § 6 para. 3 ElektroG: 40951076

Safety warnings

/ Before initial operation, please make sure to follow all safety instructions that may be provided in the product information.

/ Never use these devices in applications where the safety of a person depends on their functionality.

/ LED lighting systems can generate intensive UV radiation, which can damage your eyes in case of improper use. The manufacturer cannot be held responsible for damages that result from improper use or connection.