

WHITEPAPER

OPTICAL SENSORS

TABLE OF CONTENT

1 Introduction	3
2 Classification of optical sensors	3
3 Classification of optical sensors?	3
3.1 Through-beam systems	4
3.2 Reflection systems (retro-reflective sensors)	5
3.3 Polarizing filters	6
3.4 Devices with coaxial optics (single-lens optics)	7
3.5 Retro-reflective sensors without retro-reflector	8
3.6 Scanning systems (diffuse reflection sensors)	9
3.7 Energetic diffuse reflection sensors (intensity differentiation)	10
3.8 Diffuse reflection sensors with background suppression (color-independent)	11
3.8.1 Mechanical background suppression (triangulation principle)	12
3.8.2 Background suppression based on three-beam principle	14
3.8.3 Background suppression using diode array (triangulation principle)	15
4 Diffuse reflection sensors and light barriers with point-shaped red light LED	16
5 Contrast sensors	17
6 Color sensors	17
7 Laser sensors	19
8 Laser measurement systems for determining distances	20
9 Safety light curtains (accident prevention light curtains)	21
10 Camera sensors	22
11 Infrared sensors	23

1 INTRODUCTION

Optical and optoelectronic sensors convert optical information into electrically analyzable signals, whereby visible light, infrared radiation and ultraviolet light are primarily used for this purpose. To a certain extent, the quantum mechanical effects of light (also generally referred to as the photoelectric effect) form the basis for optical sensors.

Industrial applications for optical sensors are to be found in automation in particular. Apart from simple detection tasks, in such applications the sensors are also used for e.g. position measurements, safeguarding tasks (i.e. personal protection) as well as for distance measurements.

This white paper is intended to provide an overview of the many different types of optical sensor, to describe in detail their operating principle and areas of application and, in this context, also to explain the advantages and disadvantages of the individual systems.

2 CLASSIFICATION OF OPTICAL SENSORS

Optical sensors can be grouped into through-beam and reflection systems as well as scanning systems which also include through-beam and retro-reflective sensors, diffuse reflection sensors and laser sensors.

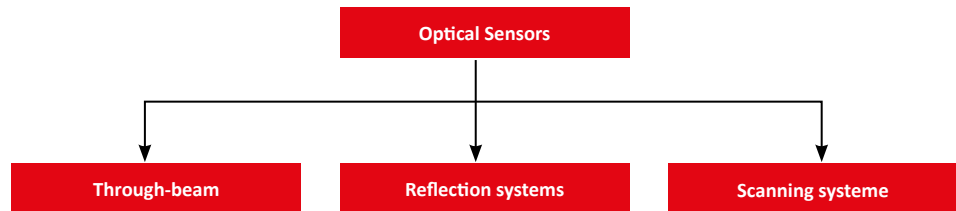

Classification of optical sensors. (all pictures: ipf electronic gmbh)

3 WHAT TYPES OF OPTICAL SENSORS ARE AVAILABLE?

The following list provides an overview of the many different optical sensors and their classification.

Through-beam systems	Reflection systems	Scanning systeme
Through-beam sensors	Retro-reflective sensors	Diffuse reflection sensors with background suppression
Fiber-optic amplifiers with glass or plastic fiber optics	Retro-reflective laser sensors	Diffuse reflection sensors without background suppression (energetic)
Forked, angled and frame light barriers	Retro-reflective sensor with point-shaped red light LED	Fiber-optic amplifiers with glass or plastic fiber optics
Color sensors		Color sensors
Through-beam laser sensors		Diffuse reflection laser sensor with background suppression
Forked and angled laser light barriers		Diffuse reflection laser sensors without background suppression (energetic)
Laser measurement systems		Diffuse reflection sensors with point-shaped red light LED
Safety light curtains		Laser measurement systems

Through-beam systems	Reflection systems	Scanning systeme
		Luminescence sensors
		Contrast sensors
		Camera sensors

3.1 THROUGH-BEAM SYSTEMS

The through-beam systems consist of a separate transmitter and receiver, whereby the transmitting optics (OS) and receiving optics (OE) must be mounted opposite each other. When an object is located between the transmitter and receiver, the light beam generated by the transmitting optics is interrupted and the sensor switches. Evaluation is based on interruption of the light beam.

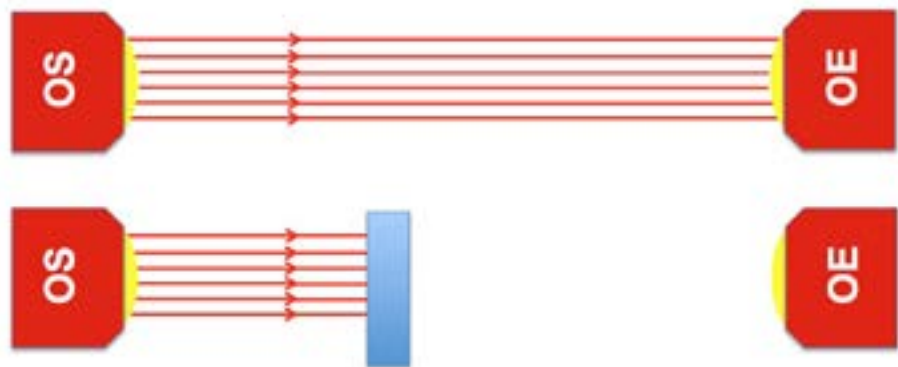

The through-beam systems evaluate interruption of the light beam.

These systems have extremely large ranges (up to 150 meters in the case of laser systems). All objects are reliably detected irrespective of their color, shape or surface, regardless of the position at which they are located within the light beam. The location at which interruption of the light beam take place within the system is therefore completely irrelevant. As far as the impact of soiling and contamination are concerned, through-beam systems rank among the least sensitive optical sensors because, unlike with reflection systems, the light only has to travel between the transmitter and receiver. The maximum range of a through-beam system is usually not fully utilized. This „buffer“ can then be used to compensate any dirt that may have become deposited on the optics of the transmitter and receiver.

The mounting of through-beam systems is extremely complicated as the transmitter and receiver must be precisely aligned with each other and both the transmitting and receiving optics require their own voltage supply. Another disadvantage is that transparent objects (e.g. bottles or jars as well as containers made of PET or films used in the packaging industry) are very difficult to detect using through-beam systems.

3.2 REFLECTION SYSTEMS (RETRO-REFLECTIVE SENSORS)

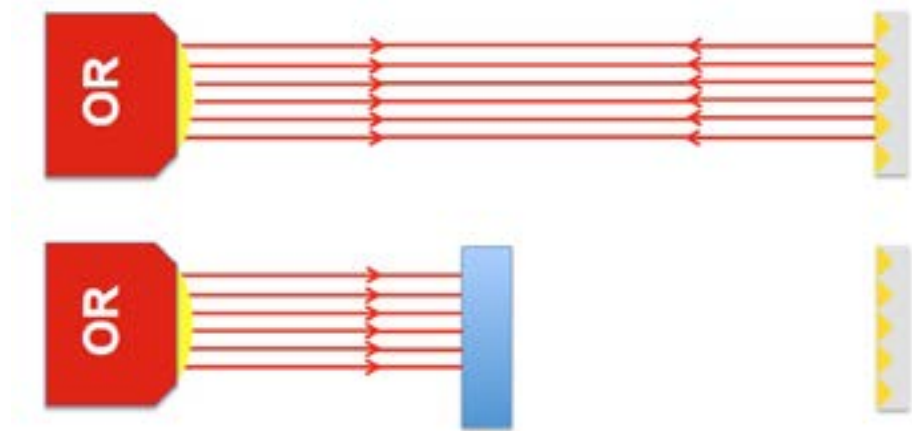

With a reflection system, a reflector (right) is required as a counterpart.

In reflection systems, the transmitter and receiver are in a single housing, which means that a reflector (triple mirror / retro-reflector) is required as a counterpart. As with through-beam systems, the reflection systems are also based on the interruption of light.

This sensor variant can also reliably detect all objects irrespective of their color, shape and surface, whereby extremely large ranges are possible depending on the size of the reflector. Unlike through-beam systems, however, the reflection systems require only one voltage supply at the device end.

The mounting of a reflection system is similar in complexity to a through-beam system. The device in which the transmitter and receiver are housed must be precisely aligned with the reflector. As already pointed out above, the size of the reflector influences the system range and therefore also the sensitivity. Transparent objects are extremely difficult to detect using such systems, and the devices must be equipped with a polarizing filter in the case of highly reflective surfaces (e.g. chrome-plated parts). The operating principle of polarizing filters is explained below.

3.3 POLARIZING FILTERS

In physics, the term „polarization“ refers to the orientation of the oscillation planes of transverse waves. In this context, „transverse“ describes the propagation characteristics of a wave and means that the oscillation occurs perpendicular to the propagation direction of the wave. A polarizing filter is therefore a polarizer for light and influences the oscillation axis of light.

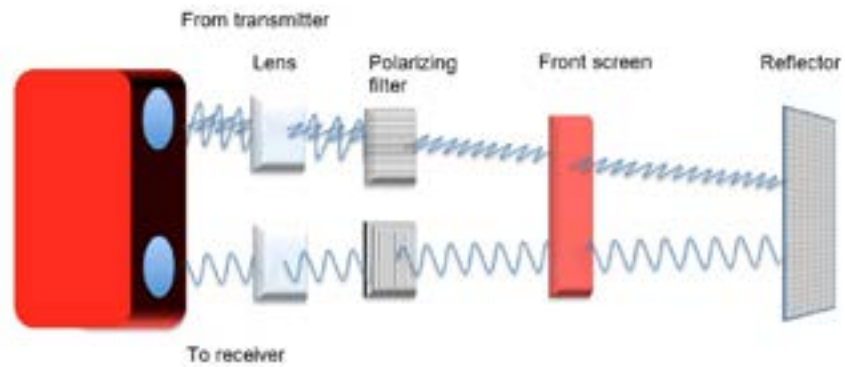

Operating principle of a polarizing filter. The filter of the transmitting optics is only permeable for a certain oscillation axis of the light. The same also applies to the filter at the receiver end.

Owing to the polarizing filter of the transmitting optics, only light of one oscillation axis leaves the device. The individual trip elements of the reflector rotate the oscillation plane of the light beam through 90°. Only in this case can the light reflected by the triple mirror pass through the polarizing filter of the receiving optics and reach the receiver.

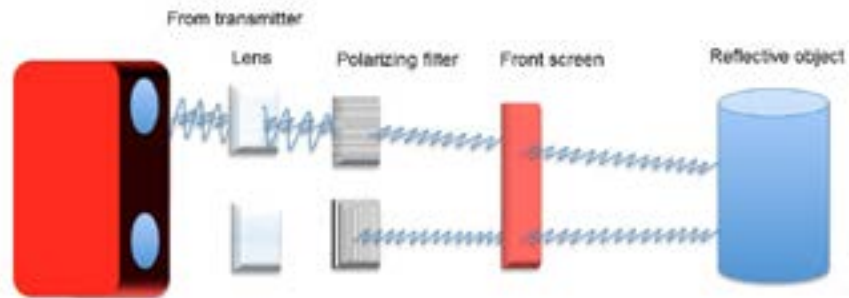

The light reflected by the object cannot pass through the polarizing filter; the object is therefore not reliably detected.

Reflective or shiny surfaces are, however, not able to influence the oscillation plane of the transmitted light beam. The light reflected by the object cannot pass through the polarizing filter and the object is not reliably detected.

If, for example, a conveyor belt is to be monitored using such a retro-reflective sensor, this can cause problems owing to the internal structure of the devices. Since the transmitter and receiver are positioned next to each other in the device, large slots must be cut into the guide rails of the conveyor belt. The danger here is that the material being conveyed on the belt could become jammed. As an alternative, it is therefore recommended to use devices with coaxial optics, also referred to as single-lens optics.

3.4 DEVICES WITH COAXIAL OPTICS (SINGLE-LENS OPTICS)



In the case of devices with coaxial optics, the transmitted and received light beam are on one axis.

In reflection systems with single-lens optics, a semi-transparent mirror is installed, behind which the transmitter is located. When the light from the transmitter hits the rear side of the mirror, it can pass through the mirror and leave the sensor. The reflected light beam, however, is deflected by 90° by the mirror and thus reaches the receiver.

As the transmitted and received light beam are on one axis, only a narrow slot or a small hole needs to be made in the guide rails of conveyor belts immediately in front of the sensor, thereby minimizing the risk of the conveyed material becoming jammed. The point at which the light beam is interrupted by the object to trigger detection is completely irrelevant. This system allows large ranges and, compared to conventional retro-reflective sensors, is easier to align to an optimum position.

However, all reflection systems as well as the versions with coaxial optics require a reflector as the reference surface. In complete contrast, so-called auto-reflective sensors function without any dirt-sensitive reflectors at all.

3.5 RETRO-REFLECTIVE SENSORS WITHOUT RETRO-REFLECTOR

These auto-reflective sensors function in a similar way to the reflection systems, but do not require any retro-reflectors as a reference surface.



Auto-reflective sensors function without dirt-sensitive triple reflectors.

Instead, these still relatively new sensors can use any diffusely reflecting surface as the reference surface. These devices are set up using a convenient teach-in procedure during which the internal processor of the device determines both the distance as well as the intensity of the light reflected by the reference surface and defines them as base values. If during operation an object to be scanned is moved into the beam path, the internal processor detects a deviation in the distance and intensity values relative to the base settings and signals this by changing the status of the switching output.

Equipped with an alignment aid, the auto-reflective sensors can be positioned and aligned optimally in combination with an LED signal.

Like the single-lens optics, such auto-reflective sensors are suitable for standard industrial applications, e.g. for detecting all types of non-transparent objects on a conveyor belt. Furthermore, devices with red light LED are also able to reliably detect transparent objects, e.g. films. A further device version uses a red light laser diode with laser safety class 1 as the transmitting element instead of a red light LED. Large operating ranges (up to max. 2000 millimeters) are possible with such devices. However, these devices cannot be used to detect transparent objects.

3.6 SCANNING SYSTEMS (DIFFUSE REFLECTION SENSORS)

Scanning systems integrate the transmitter and receiver in a single device and do not require a counterpart such as a reflector as a reference surface because the reflection of the light beam from the object to be detected is evaluated.

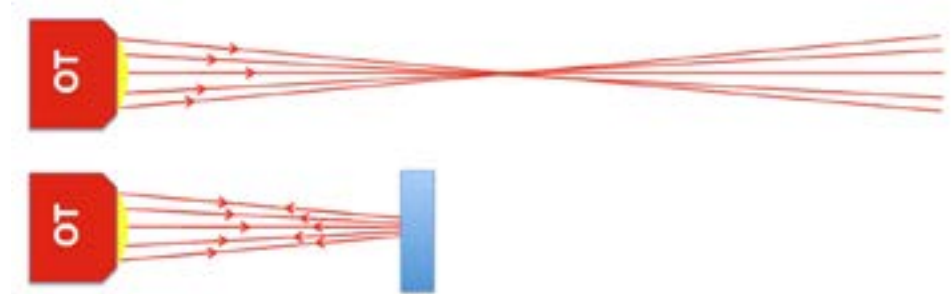

Scanning systems evaluate the light beam that is reflected by an object.

One advantage of scanning systems is their uncomplicated installation. In addition, these sensors can be used without a counterpart (e.g. retro-reflector).

With curved or shiny surfaces, however, the sensor light beam must hit the material surface as perpendicularly as possible. The effect whereby the receiver cannot detect the light beam reflected by an object is particularly evident in the case of shiny objects. With such objects, the so-called law of reflection (angle of incidence = angle of reflection or $\alpha = \beta$) becomes noticeable as the shininess of the surface increases, i.e. if the angle of incidence of the transmitted light beam is too great, the light reflected by the object surface can no longer reach the receiver.

Transparent objects are also extremely difficult for optical diffuse reflection sensors to detect. Furthermore, the object to be detected must not be at a position in the light beam that is too close in front of the sensor. In this case, the light reflected by the object might no longer reach the receiver next to the transmitter inside the device. The resulting „blind range“ is, however, not constant but instead varies depending on the reflection properties of the object surface. To put it more simply, the more shiny the object surface is, the greater the blind range will be.

3.7 ENERGETIC DIFFUSE REFLECTION SENSORS (INTENSITY DIFFERENTIATION)



Energetic diffuse reflection sensors reliably detect objects that reflect sufficient light.

Energetic diffuse reflection sensors operate according to the principle of intensity differentiation. For this purpose, a specific amount of light (sensitivity) is set at the sensor, usually using a potentiometer. If the amount of light reflected by the object reaches or exceeds this preset threshold, the device switches on. If only a small amount of light is reflected by the object to be detected (intensity), the sensor does not receive a switching signal.

The design of the system means that energetic diffuse reflection sensors reliably detect all objects that reflect sufficient light, i.e. objects that reflect enough light for the switching threshold to be exceeded. As a result, only objects with sufficient reflectivity can be detected reliably.

With the same basic sensitivity, the response behavior of the diffuse reflection sensor can differ in the case of material surfaces with a greatly varying degree of reflection. For example, dark materials can be extremely difficult to detect or cannot be detected in front of light backgrounds because as a result of such backgrounds the diffuse reflection sensor receives a strong reflection signal which may already exceed the necessarily low switching threshold setting.

The surface texture of the objects to be detected poses a further problem. The rougher the objects are, the greater the light dispersion will be, which in turn has a negative effect on the range and sensitivity of energetic diffuse reflection sensors. Conversely this means: The smoother the surface is, the better the response behavior of the sensor will be – always provided that the surface of the object to be detected is at an angle of 90 degrees relative to the sensor, i.e. the transmit signal.

3.8 DIFFUSE REFLECTION SENSORS WITH BACKGROUND SUPPRESSION (COLOR-INDEPENDENT)

The problems that arise with energetic diffuse reflection sensors are essentially eliminated by diffuse reflection sensors with background suppression.



Diffuse reflection sensors like the **OT43** detect material irrespective of color, size and surface.

These devices detect material in the sensing range largely irrespective of their degree of reflection (color, surface).

The basis for this operating principle is that the used receiver elements evaluate the object position from which the incident transmitted light is reflected. From this it is possible to determine whether the object is in the selected detection and switching range. The basic requirement is, of course, that the object surface can reflect the incident transmitted light sufficiently. Thus the effective sensing range is not dependent on the object to be detected but only on the set sensing distance. This allows the reliable suppression of a disruptive background. Owing to this feature, the devices are also referred to as „diffuse reflection sensors with background suppression“ – a description that is representative of material-independent object detection with scanning systems.

From a technical viewpoint, this functionality can be realized by means of three different concepts. These are: systems with mechanically adjustable receiving elements (mechanical background suppression / triangulation principle), systems with triple-beam optics (background suppression according to the three-beam principle) or systems with a diode array (electronic background suppression / triangulation).

3.8.1 MECHANICAL BACKGROUND SUPPRESSION (TRIANGULATION PRINCIPLE)

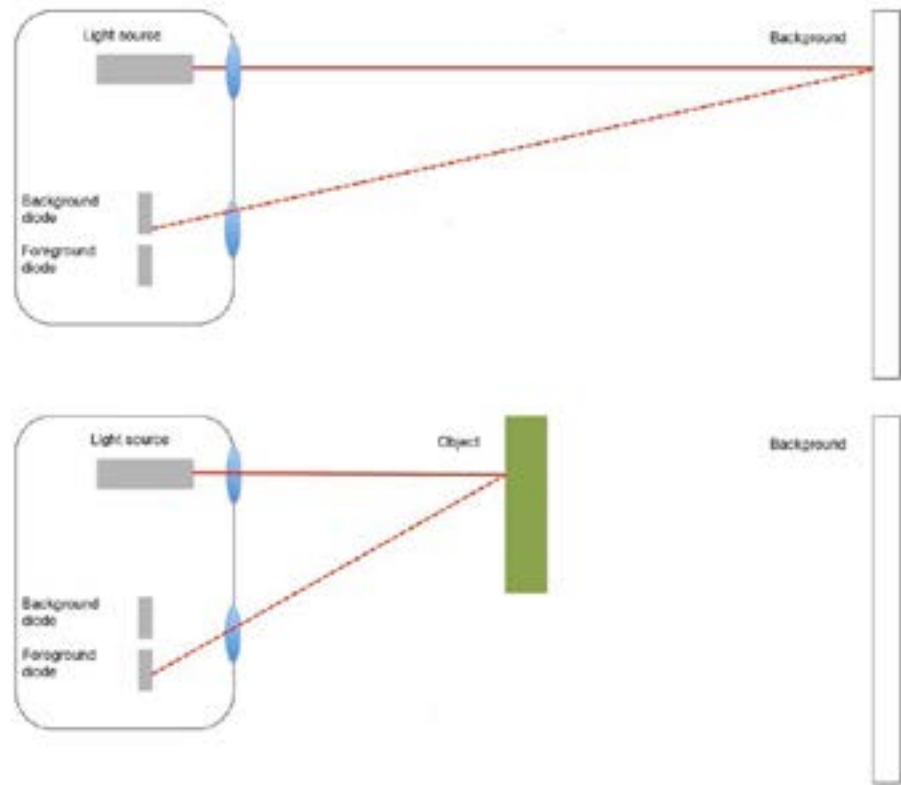

Operating principle of mechanical background suppression.

The Figure explains the operating principle behind mechanical background suppression. Two receivers, i.e. diodes (background and foreground diode), are positioned next to each other on an adjustable carriage. Depending on which receiver is generating an output signal (determined by the incident reflection light beam), it is possible to say precisely whether or not the object is located within the predefined detection range. With these devices, the detection range can be adjusted by moving the receiver. This is done mechanically by means of a spindle.

The main advantage of diffuser reflection sensors with mechanical background suppression is their extremely high setting accuracy, which allows objects to be detected extremely well regardless of their color. On the other hand, objects in the background are not detected.

However, the technical properties of these diffuse reflection sensors fall away slightly toward the end of the operating range. In other words, detection of dark objects or rough material surfaces becomes more difficult and the switching point accuracy decreases.

As with all optical sensors, this can be explained in the context of dark or rough object surfaces by the photometric distance law.

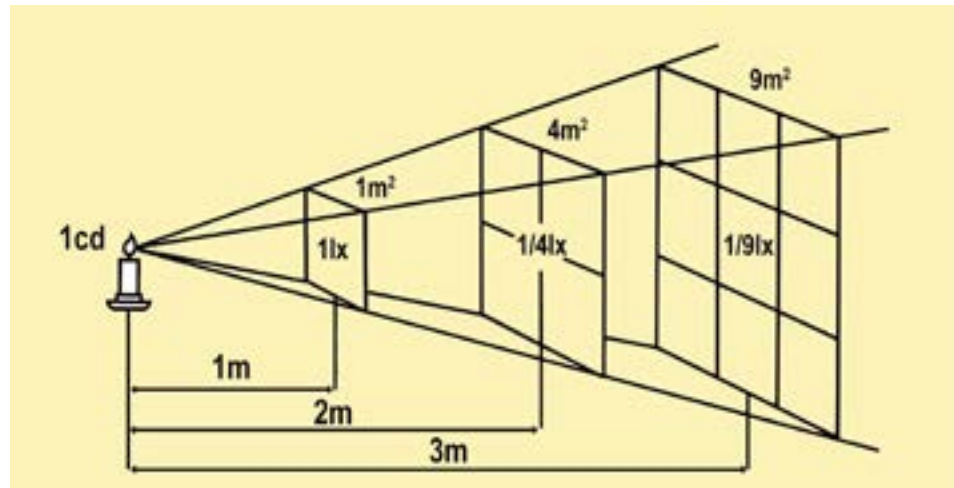

The photometric distance law states that illuminance decreases by the square of the light source.

The further away an object is from the sensor, the less the amount of light reaching the object will be. However, the receiver or diodes of the diffuse reflection sensor with mechanical background suppression requires a minimum amount of light to actually be able to react and to generate an evaluable signal. If the distance to the object is very great (small amount of light owing to the photometric distance law) and additionally the object surface is dark and/or rough (very poor reflectivity of the surface), the sum of these two effects can result in the response threshold of the receiving elements not being reached.

The reason for the diminishing switching point accuracy in the long-distance range is that the transition between the foreground and background (i.e. the switching on and off of the sensor) becomes increasingly „fuzzy“ as the object distance increases. This is because the geometric displacement of the light spot at the two receivers/diodes in the case of object position displacement becomes smaller and smaller as the distance increases.

Furthermore, the mechanics for adjusting the detection range is susceptible to interference, such as extremely strong vibrations, and can lead to failure of the diffuse reflection sensor. In this context, background suppression according to the three-beam principle represents a genuine advancement.

3.8.2 BACKGROUND SUPPRESSION BASED ON THREE-BEAM PRINCIPLE

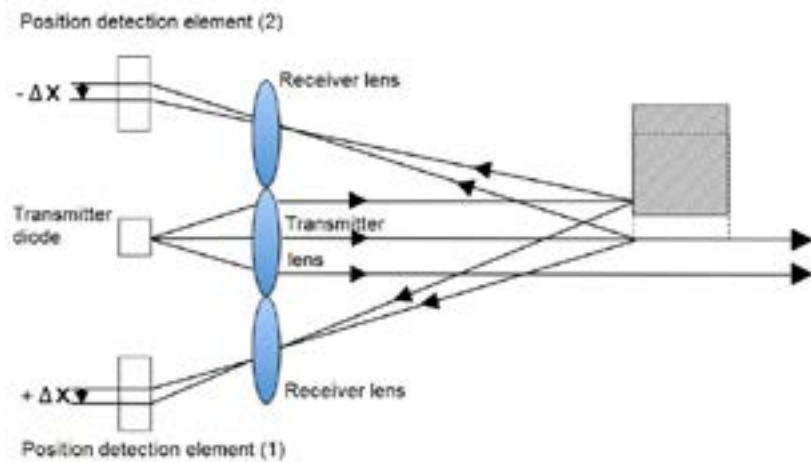

Operating principle of background suppression according to the three-beam.

Two receivers (position detection element 1 and 2) are positioned symmetrical to the axis of the light source. When an object moves through the transmitted light beam, the image of this object on the receiver element (1) is at a position different to that which would be the case if the moved object fully reflected the beam. This results in a deviation $+\Delta x$ on the receiver element (1) for both positions of the object. Owing to the symmetrical arrangement of the receiver (2), a deviation of $-\Delta x$ is found there for both positions of the object. The exact distance of the object can be determined by calculating the mean of both displays. Based on the light spot displacement of the received signal, the flat position detection elements can thus detect the change in distance of a detected object. Since two detection elements are used, it is possible to determine with an extremely high degree of accuracy the distance from which the received signal returns and, therefore, the distance at which the object is located relative to the sensor.

The advantages of the three-beam principle are that detection using these sensors can be performed largely irrespective of the object color, whereby objects in the background are not detected. Furthermore, devices that operate according to this principle have a high response speed so that objects that move through the detection zone very quickly are also detected reliably. As such sensors do not have any moving parts in the device, they are extremely resistant to vibration (up to 100 G) and, because they have three optics, they are also much less sensitive to soiling. Objects are detected largely irrespective of the angle, which means that the sensor light beam does not necessarily have to hit the object surface perpendicularly.

However, the technical properties of optical sensors with three-beam principle fall away toward the end of the operating range more sharply than in the case of sensors with mechanical background suppression.

3.8.3 BACKGROUND SUPPRESSION USING DIODE ARRAY (TRIANGULATION PRINCIPLE)

In the case of background suppression with a diode array, a microcontroller reads out a large number of diodes (128 or more) on an array individually and evaluates the signal. Owing to the large number of diodes, the position and distance of an object can be specified accurately and it can be determined whether or not the object is in the detection range. For this purpose, a teach-in procedure is used to divide the diode array into two receiver groups for the foreground and background.

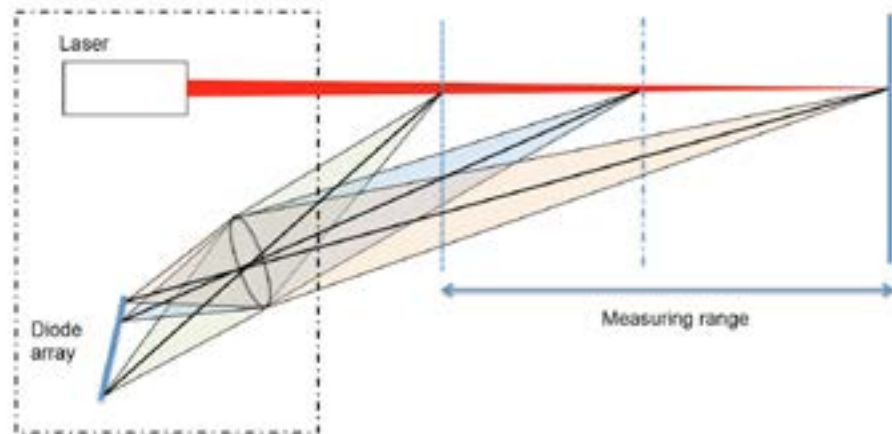

Operating principle of background suppression with a diode array.

Devices with background suppression using a diode array mostly have an excellent response and color behavior across the entire operating range. The reason behind this is that in the areas of the array in which the light spot displacement at large distances is still very small, the number of diodes is increased and their distance relative to each other is reduced. Due to the high component density of the diodes in this area of the array, the light spot displacement can still be resolved extremely well. Like devices with background suppression according to the three-beam principle, sensors with integrated diode array do not have any moving parts and are therefore extremely robust. Furthermore, they have a high setting accuracy and high response speed.

4 DIFFUSE REFLECTION SENSORS AND LIGHT BARRIERS WITH POINT-SHAPED RED LIGHT LED

Devices with point-shaped red light LED are still very recent developments in the area of diffuse reflection sensors with background suppression and retro-reflective sensors with and without retro-reflector. The small, homogeneous and sharp-edged light spot of the point-shaped red light LED allows these sensors to be positioned extremely precisely and, similar to laser sensors (cf. page 22), to detect very small objects reliably. A special feature of these devices, which are also available with a standard LED, is the uniform housing concept in the sizes 33 and 45 which promises more freedom for the development of applications for a wide variety of different industrial sectors.



A special feature is the uniform housing concept in the size 33 and 45.

As was previously the case with other housing designs, this housing concept makes it possible to definitively decide on the sensor principle and the device light source (standard LED or point-shaped red light LED) at a later design phase.

A further advantage of these sensors is their precisely aligned transmitter optics. They allow e.g. the retro-reflective sensors of the device series with so-called „single-lens optics“ to detect objects in the near range even through extremely small openings with a diameter of less than 4 mm. The special optics also have the advantage of the sensor not needing to be realigned if the device is replaced.

5 CONTRAST SENSORS

Contrast sensors function according to the principle of intensity and gray tone differentiation. If the distance of an object to the sensor remains constant and the surface of this object varies, this can be ascertained by means of the intensity. Contrast sensors are therefore suitable for differentiating both light and dark surfaces (mark detection).

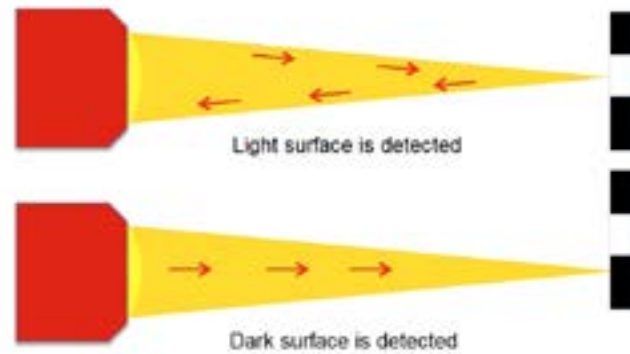

Intensity and gray tone differentiation by means of a contrast sensor.

Contrast sensors also have no moving parts in the device and are therefore very robust with regard to vibration. Further advantages are their resistance to soiling and their high response speed.

For a contrast sensor to function properly, however, the markings on objects must be complete and unbroken and must be at least as large as the light spot generated by the sensor. Furthermore, the devices operate reliably and therefore safely only within narrow distance tolerances.

6 COLOR SENSORS

ipf electronic has devoted a separate white paper to the extensive topic of color sensors, or „true color“ sensors (colors as perceived by humans). The white paper written by Dipl.-Ing. Christian Fiebach can be downloaded under the following link: „True color“ sensors.



Luminescence sensor.

Luminescence sensors use UV light to detect the luminophores¹ in various materials which then trigger a switching operation. Luminophores are pigments that become luminous under UV light – an effect which is used in various industrial applications. Luminescence sensors function according to the principle of spectral shift, whereby the short-wave UV light of the sensor light source is converted into visible long-wave radiation by luminescent substances (e.g. brightening agents, softening agents, and also invisible agents used for marking objects, etc.) in a material.

The device receiver is fitted with corresponding spectral filters so that it reacts only to this radiation.

¹ A luminophore is a substance that emits lights in the dark after it has been exposed to short-wave light. This phenomenon is based on phosphorescence or fluorescence.

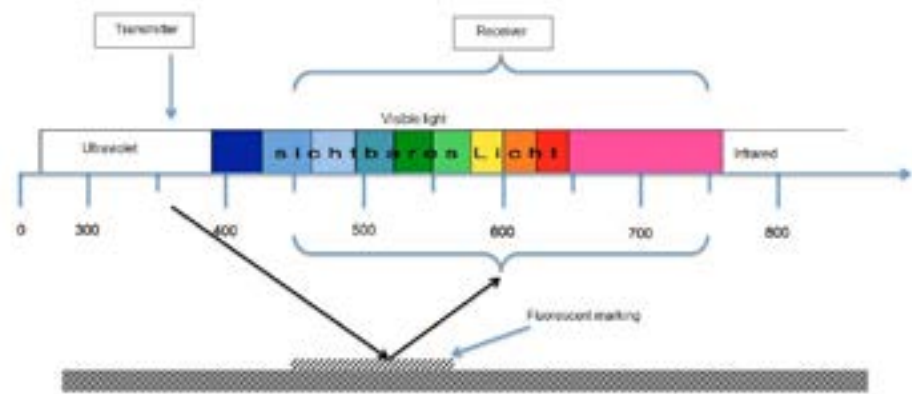

Luminescence sensors function according to the principle of spectral shift.

Large object distances can be achieved using luminescence sensors, whereby the sensor light beam does not necessarily have to hit the surface to be detected perpendicularly (detection functions largely irrespective of the angle). Moreover, minor damage to invisible markings on objects is noncritical.

Such sensors can withstand even severe vibration as they do not contain any moving parts. Furthermore, they have a high degree of contamination compensation. Additionally, changes in distance to the test object are noncritical and the background does not affect the scanning reliability of such devices.

The materials and marking agents used for detection must contain luminescent substances so that the optical sensor can actually work.

7 LASER SENSORS

Laser sensors are the preferred choice wherever great demands are placed on resolution, repeat accuracy, reliability, switching frequency, sensing range and operating range. The use of these sensors with their small, extremely focused and therefore spatially restricted laser light spot opens up an extraordinarily broad range of applications.

As the transmitters of such sensors comply with laser class 1 or 2 as per EN 60825, no additional protective measures are required for using the devices.

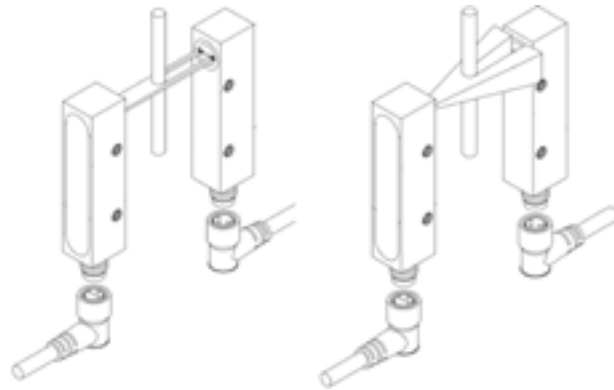

Laser light barrier on left; conventional light barrier on right.

Laser light barriers (left) permit extremely large operating ranges. With through-beam systems, the position at which the light beam is interrupted is irrelevant. An exact shadow projection of the object to be detected hits the receiver of the sensor, which means that the distance of the measurement objects from the transmitter and receiver has to a large extent no effect on the measurement signal. The same applies to the sensors themselves. As mutual interference rarely occurs, multiple sensors can be operated in a confined space.

The visible laser beam enables simple alignment of the devices, whereby the extremely small diameter of the laser beam means that even objects the same size as a human hair can be detected. In addition, apertures and optics ensure uniform light distribution in the laser beam as well as a sharp beam boundary.

Despite the many positive features, laser sensors also have a number of disadvantages: For example, they have difficulty detecting transparent objects. Additionally, extremely rough surface structures, such as raw casts or sand-blasted components, scatter the laser beam so strongly that problems can arise in the case of scanning systems. With materials with curved or shiny surfaces, the sensor light beam of diffuse reflection laser sensors must hit the surface as perpendicularly as possible. Furthermore, it is important to note that the laser beam diameter in the case of certain sensor versions is not constant over the entire operating range.

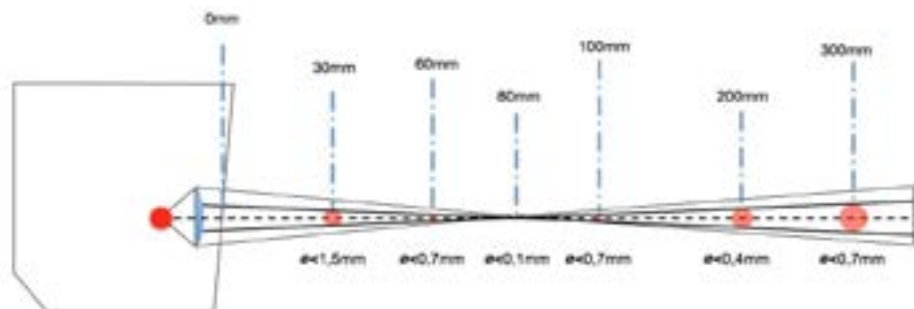

The smallest objects can be detected at the focus of the laser beam. The positioning and repeat accuracy is also greatest at this point.

8 LASER MEASUREMENT SYSTEMS FOR DETERMINING DISTANCES

Distance measurement using laser measurement systems is based on the triangulation principle.

Laser distance sensors are very precise and can therefore resolve the distance to an object in extremely small increments. They are therefore ideal for measurement procedures on small and fast moving objects. These devices are even able to reliably measure objects with frequently changing colors over a distance of up to 1 m.

The distance measurement can be performed using a diode array integrated in the sensor. As already mentioned on pages 15 to 16 regarding the topic of background suppression, 128 diodes or more are read out individually by means of a microcontroller. The high number of diodes and internal determination of the median point of intensity distribution by means of a subpixel calculation (8192 subpixels) enable the position of the object to be determined precisely. This position is then output as an analog signal proportional to distance.

Special laser distance sensors with special light beam geometries have been developed for detecting objects with porous or rough surfaces. The use of a fine laser line on such devices means that varying structures of the object surfaces have a considerably smaller effect or even no effect at all on the reliability and precision of distance measurement.

In order to reduce the effect of greatly varying reflection properties or object colors on the measurements, the sensors have an integrated control circuit. This regulates the output of the device's laser diode according to the surface properties of an object and depending on the quality of the receiver signal. With dark surfaces the diode therefore has a high intensity and with light surfaces a low intensity. In this way, the measurement results can be formed virtually independent of the color. By means of integrated teach options, it is also possible to set the used measuring range to smaller limits within the factory-defined measuring range. As a result, the current and voltage output receive a new, customized characteristic curve.



Laser measurement system for distance measurement according to the phase

Aside from the use of an integrated diode array, another measuring principle is employed in the case of relatively large measuring distances. The reason for this is the increasing measurement inaccuracy at larger distances which arise from the triangulation principle described above.

With the so-called „phase comparison method“, the transmitted light source (laser LED) is pulsed at a fixed frequency, i.e. switched on and off at fixed intervals. This results in a defined phase position for the transmitted light beam. The pulsed light beam is emitted from the sensor, passes through the space up to the object, is reflected by the object and reaches the receiver unit integrated in the sensor. Owing to the distance that the light beam travels between the sensor and object, the receive signal is subject to a distance-dependent phase shift. This phase shift is determined in the device and converted into a measurement signal which is proportional to distance.

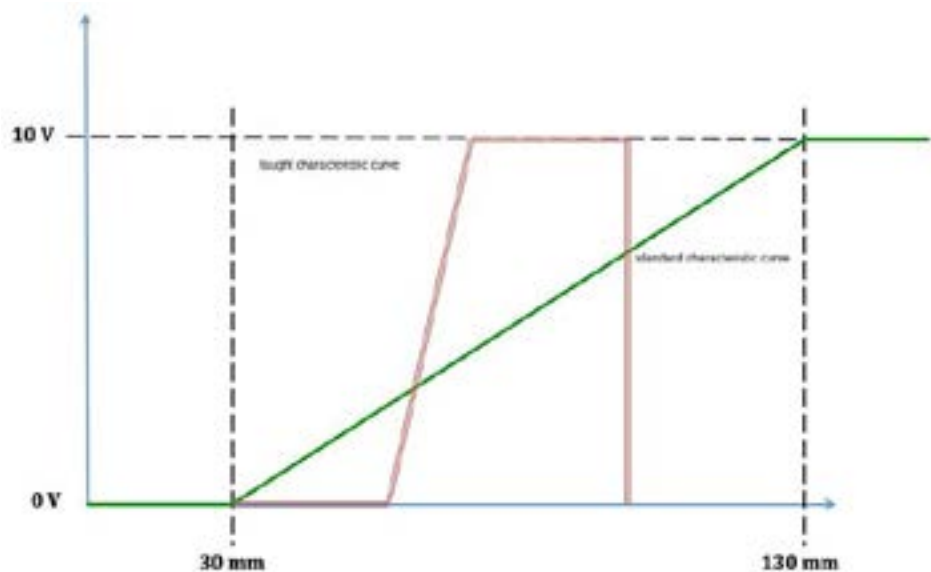

Owing to the distance that the light beam travels between the sensor and object, there is a phase shift between the transmit signal (red) and receive signal (green) which is proportional to the distance.

9 SAFETY LIGHT CURTAINS (ACCIDENT PREVENTION LIGHT CURTAINS)

Compliance with the standards IEC 61496-1 and IEC 61496-2 (Safety of machinery – Electro-sensitive protective equipment, part 1 and part 2) means that these light curtains are suitable for safeguarding hazardous areas. They are available in resolutions for finger protection (14 mm), hand protection (30 mm) and body protection (> 40 mm).

By using safety light curtains, it is possible to safeguard hazardous areas reliably without obstructing them. In this way, large areas in which potential hazards for personnel exist can also be safeguarded. It is even possible to safeguard several sides of an installation by means of corresponding deflection mirrors. In addition, all systems are self-monitoring and therefore intrinsically safe.

The disadvantages of safety light curtains are that the transmitter and receiver must always be aligned with each other and each requires its own voltage supply. Furthermore, the use of invisible infrared light means can result in unwanted triggering, especially if the transmitter and receiver are installed at a large distance from each other.

10 CAMERA SENSORS



Camera sensor **OC53** from ipf.

Camera sensors are complete, software-controlled image processing units in a compact metal housing that integrates optics, illumination and electronics. The application areas for these devices range from classic sensor systems, such as through-beam systems and diffuse reflection sensors, to industrial image processing. Thus, camera sensors can be used in any application where mounting, transport, sorting or packaging is performed automatically.

The integrated light source of such devices can be infrared or white light. To allow evaluation in transmitted light mode, wide-area background lamps are used for backlighting the components.

The camera sensors are parameterized using Windows software or a so-called web interface. The software has a variety of testing tools, whereby the software interface is intuitive to make handling the camera sensors in practice as easy as possible. The web interface can be customized to give users easy access to the visualization and setting options that they require.

After parameterization, a camera sensor operates completely autonomously (i.e. as a „stand-alone“ device). With up to more than 255 stored test routines, the device can if required be quickly adapted to changing products in production environments. The position and orientation of the components to be checked are irrelevant here. The routines can be changed over externally via digital inputs, e.g. via a PLC.

It is possible to check up to 32 test points per routine, whereby different testing functions and tools are available for evaluating the respective components. The inspection results are sent to the higher-level control system via digital switching outputs.

Owing to the adjustable focusing of the camera sensor and the choice between two pre-defined lens focal lengths, the system can also be optimally adapted to the mechanical conditions that exist on site at a production facility.

A camera sensor replaces up to 255 x 32 conventional sensors and guarantees 100 percent production monitoring with constant testing quality, whereby the inspection images can be stored in order to document the production quality.

However, along with the many advantages are a few disadvantages. For example, a camera sensor should be protected against interference from external light sources. Furthermore, the test field of a camera sensor is limited to a certain size and resolution. In addition, such sensors can „see“ only gray tones, which means that reliable test results can only be achieved if sufficient contrast levels are present.

As with the topic of color sensors, ipf electronic has also devoted a separate white paper to the subject of camera sensors entitled „What Needs To Be Observed When Using Camera Sensor Systems?“.

11 INFRARED SENSORS



Infrared sensors hold a special position.

Infrared sensors hold a special position among optical sensors. They capture the infrared radiation emitted from objects using a detector which converts the radiation into an electrical signal. This signal is amplified and transformed into a linearized measured value which is proportional to the object temperature. The measured value can be output as an analog signal or as a switching signal when predefined limits are exceeded. The sensor therefore switches when an object with sufficient infrared radiation (temperature) is within the detection range of the sensor.

Infrared sensors are primarily used in applications where conventional diffuse reflection sensors cannot be used because the switching distance of such conventional sensors is too small, the sensors are disturbed by the thermal radiation of the object, or they would be severely fouled as a result of the environmental conditions.

In addition to determining whether or not an object is present at the detection location, such sensors can nowadays also be used for temperature measurements. However, the respective material on which the measurements are to be performed must be taken into consideration because different materials have different thermal signatures.

© ipf electronic gmbh: This white paper is protected by copyright. Use of the text (even in part) and of image material included in this document is permitted only with the written consent of ipf electronic GmbH.

